



**JARLTECH**

*ISO 9001 Certified*  
*Lead with technology*  
*Win customers with service*

# **Touch POS System**

## **SERIES 8805**

**Verson:1.0**

**OPERATION**

**MANUAL**

**Table of Contents:**

**Chapter 1 Introduction .....2**

**Chapter 2 Appearance .....4**

**Chapter 3 Installation .....6**

**Chapter 4 Commands for Peripheral Controlling .....88**

**Chapter 5 Hardware Configuration .....91**

**Chapter 6 Hardware Specification ..... 105**

**Appendix – LAN Controller..... 117**

**CHAPTER 1*****Introduction*****Preview**

Jarltech is defining the New Age of POS with its integrated TouchPOS. The 8805 is designed on NB base with Intel Celeron M processor 1 GHz or above, Two slot of DDR SODIMM memory max up to 2GB; 15" TFT-LCD with resistive touch screen; built-in VGA, LAN chip, Internal IDE Hard disk (20GB or above).

Thus designation helps user easy and comfortable to handle. Its multi-functional capability makes it suitable for software developments under **Windows XP, XP Embedded, XP professional for Embedded, WIN 2000 professional Embedded, WIN NT 4.0, Linux, Redhat 7.2, WIN98, ME.**

The 8805's functionality extends far beyond the standard setup. 8805 can be adapted for a variety of uses with the addition of any of the following options: Magnetic Card Reader, Smart Card Reader, 20 x 2 VFD customer display, the second 10.4" TFT LCD display, cashdrawer, i-Button , Fingerprint , Wi-Fi , RFID , USB Key-locker or USB devices (all available upon request).

The brand new Touch POS 8805 has been designed with all advantages from JARLTECH POS series, but less cost to customer with its interactive transaction, RFID and smart card reader design provides multiple clerk access and customer database management, suitable and superior for super-market, hotel, convenience store, restaurants and any organization or store that needs point of service.

***Notes: Must to adjust display setting in BIOS first.***

***Advanced Chipset Features***

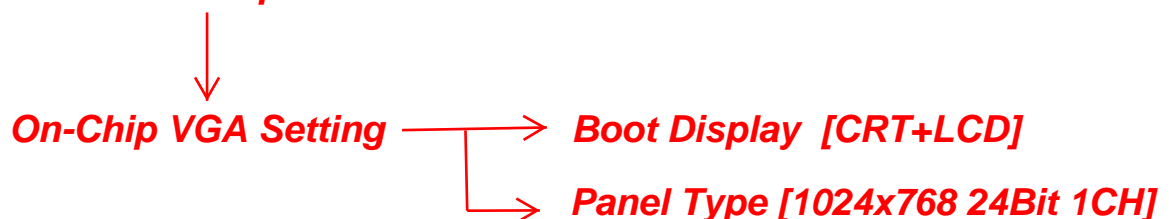

## FCC

This device complies with part 15 of the FCC rules. Operation is subject to the following two conditions:

- (1) This device may not cause harmful interference
- (2) This device must accept any interference received, including interference that may cause undesired operation.



## CE MARK



This device complies with the requirements of the EEC directive 89/336/EEC with regard to "Electromagnetic compatibility" and 73/23/EEC "Low Voltage Directive".

## CAUTION ON LITHIUM BATTERIES

There is a danger of explosion if the battery is replaced incorrectly. Replace only with the same or equivalent type recommended by the manufacturer. Discard used batteries according to the manufacturer's instructions.

## LEGISLATION AND WEEE SYMBOL

2002/96/EC Waste Electrical and Electronic Equipment Directive on the treatment, collection, recycling and disposal of electric and electronic devices and their components.



# CHAPTER 2

# Appearance

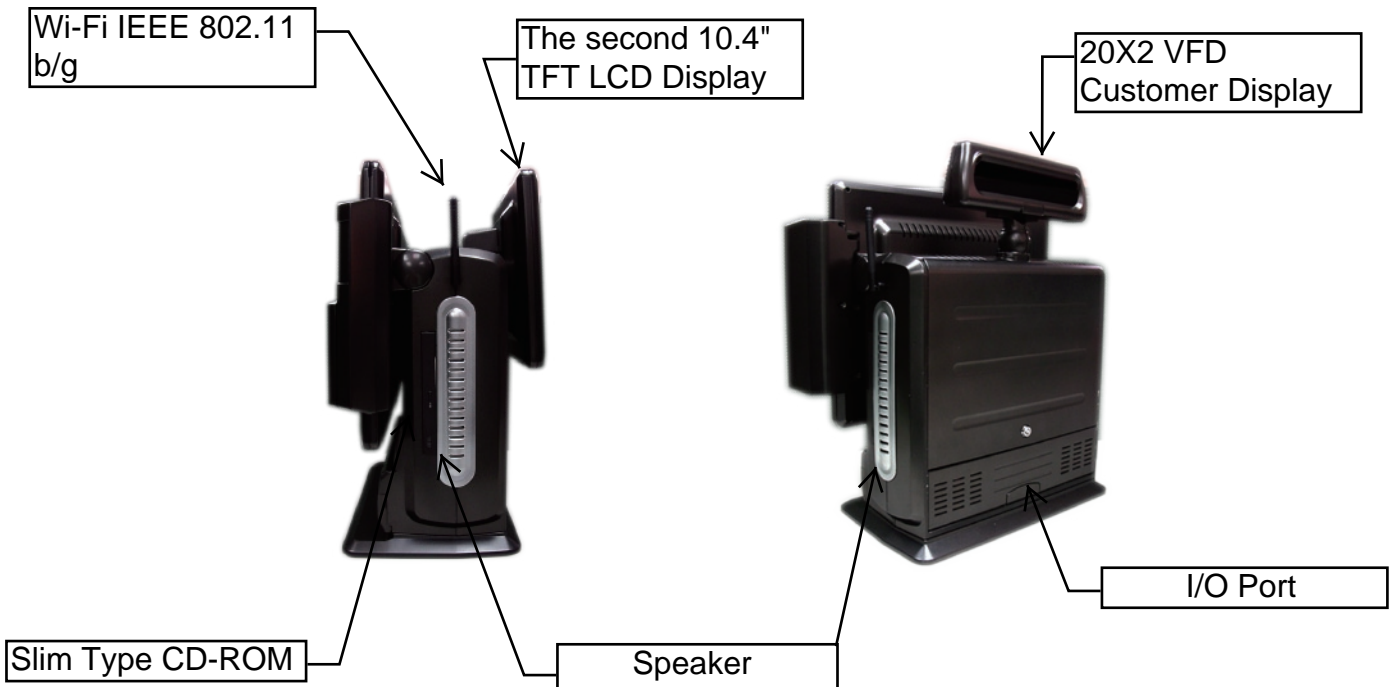

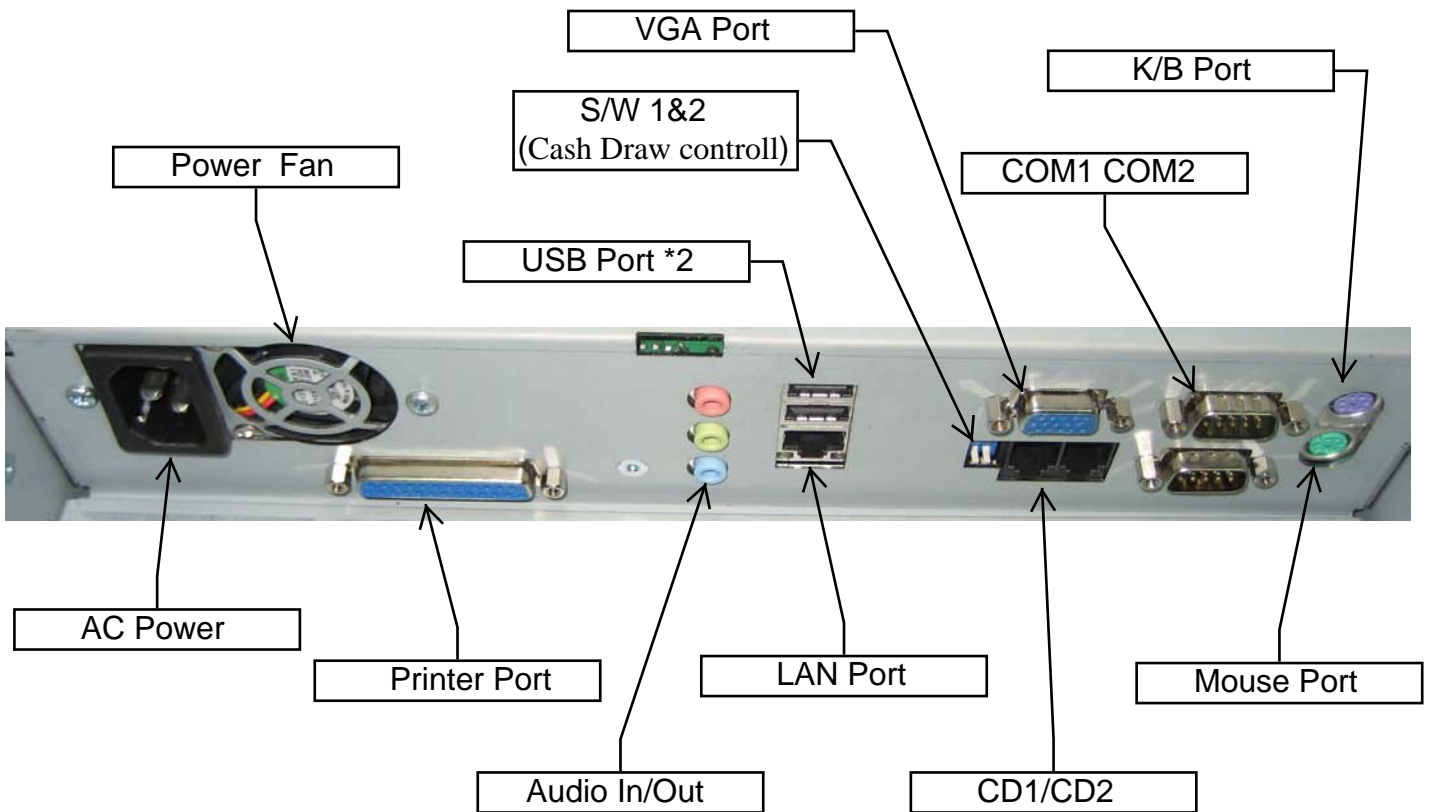

**COM1/COM2:** Standard DB9 PIN Serial port

**Mouse:** PS2 mouse socket

**K/B:** PS2 Keyboard socket

**USB:** USB port X 2

**VGA:** 15 Pins VGA Connector

**LAN:** Ethernet connector

**Multi-Media:** Line Out / MIC / Line-In

**CD1/CD2:** Cash Draw 1(beside S/W) and Cash Draw 2

**S/W(Cash Draw controll):** Switch button – S/W1 S/W2; ↓ = ON, ↑ = OFF (Default S/W1=OFF , S/W2=OFF)

**Power:** Connect to ATX power supply

**CAUTION:** While installing any additional hardware device, please make sure to shut down the computer power.  
(USB device is not subject to the limits.)

## **CHAPTER 3** *Driver Installation*

### **Touch Drivers**



**Insert CD Rom and select "Driver & Manual" folder.**

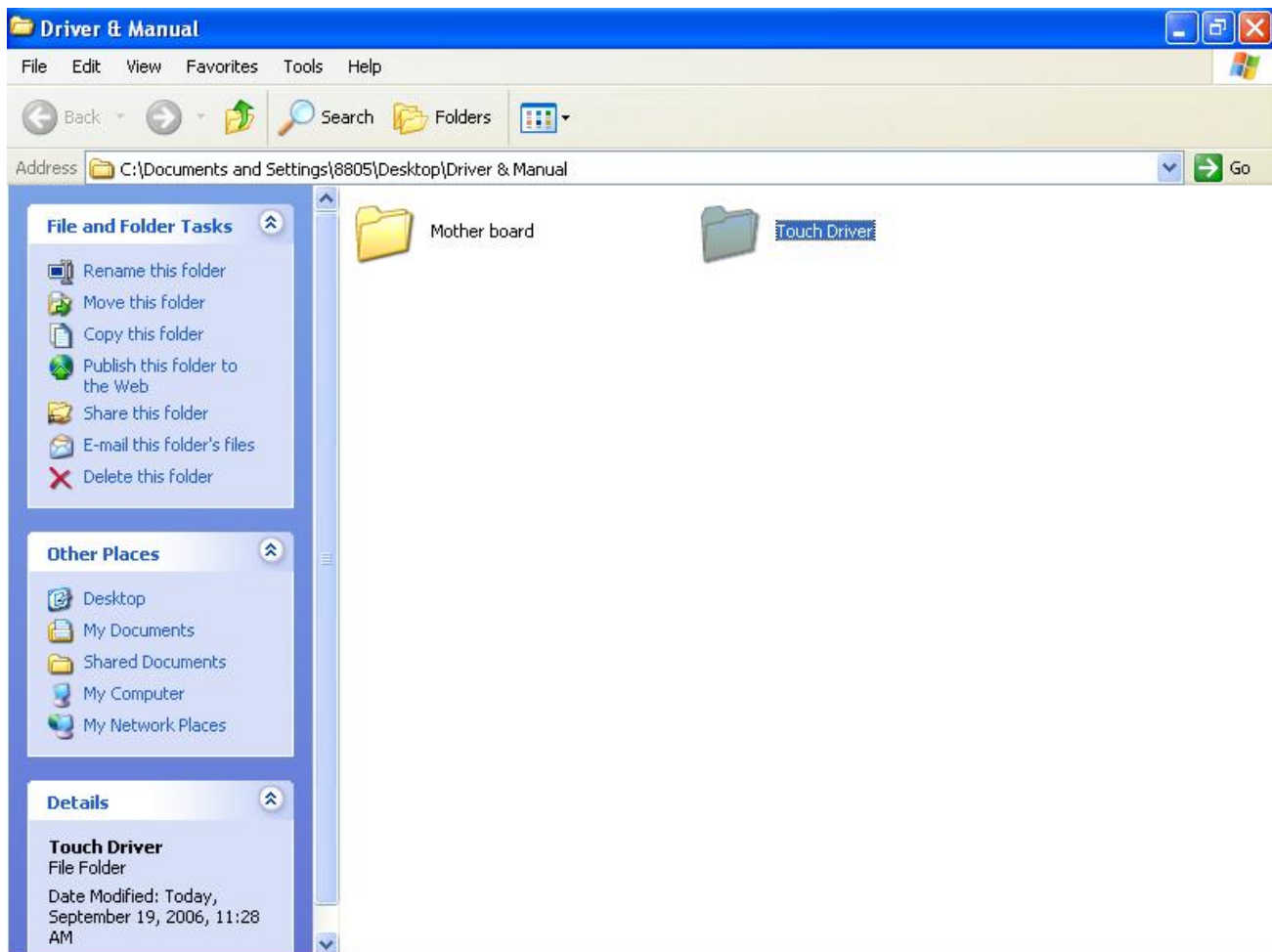

Select "Touch Driver" folder.



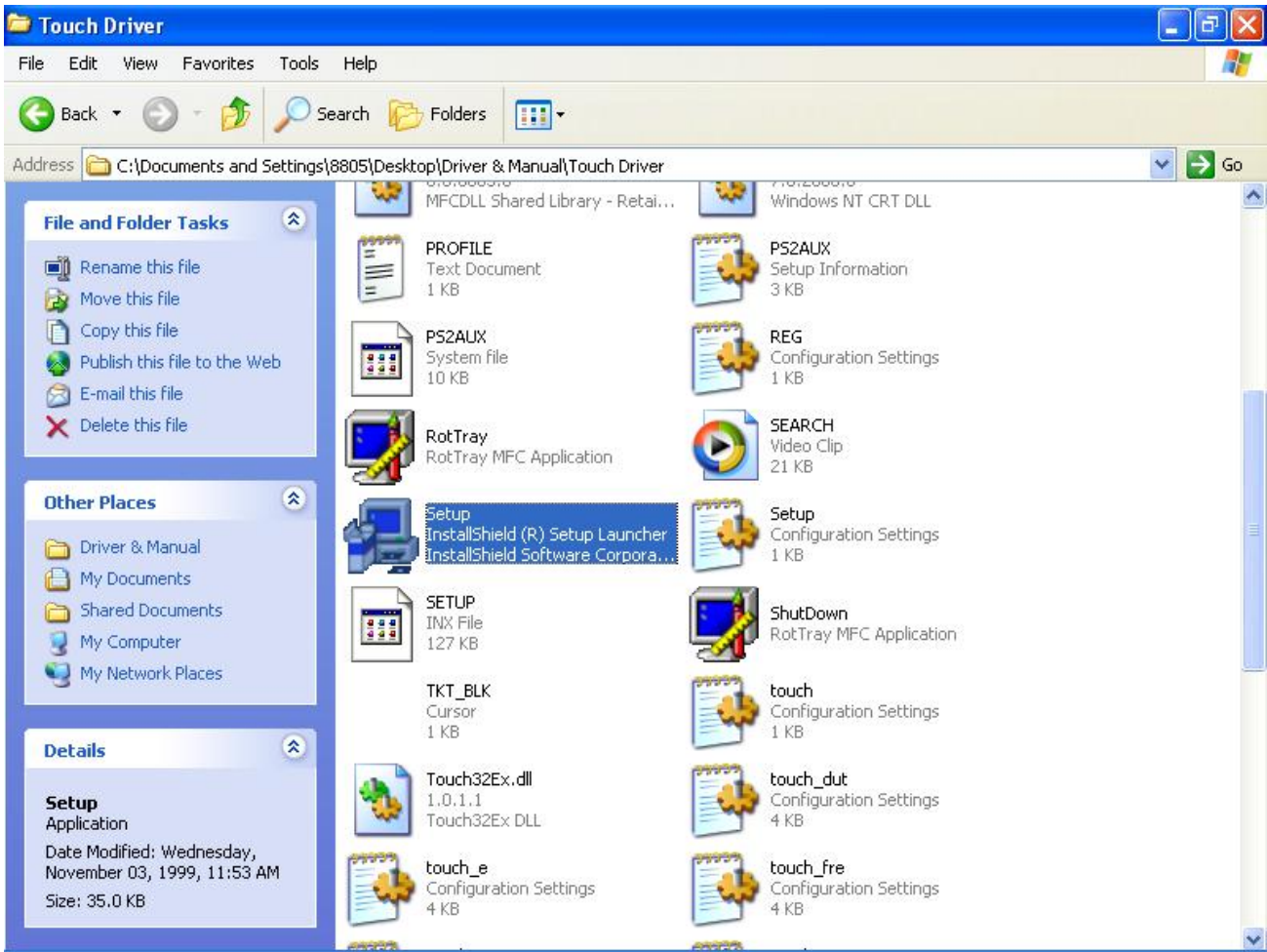

**Access the "Setup".**

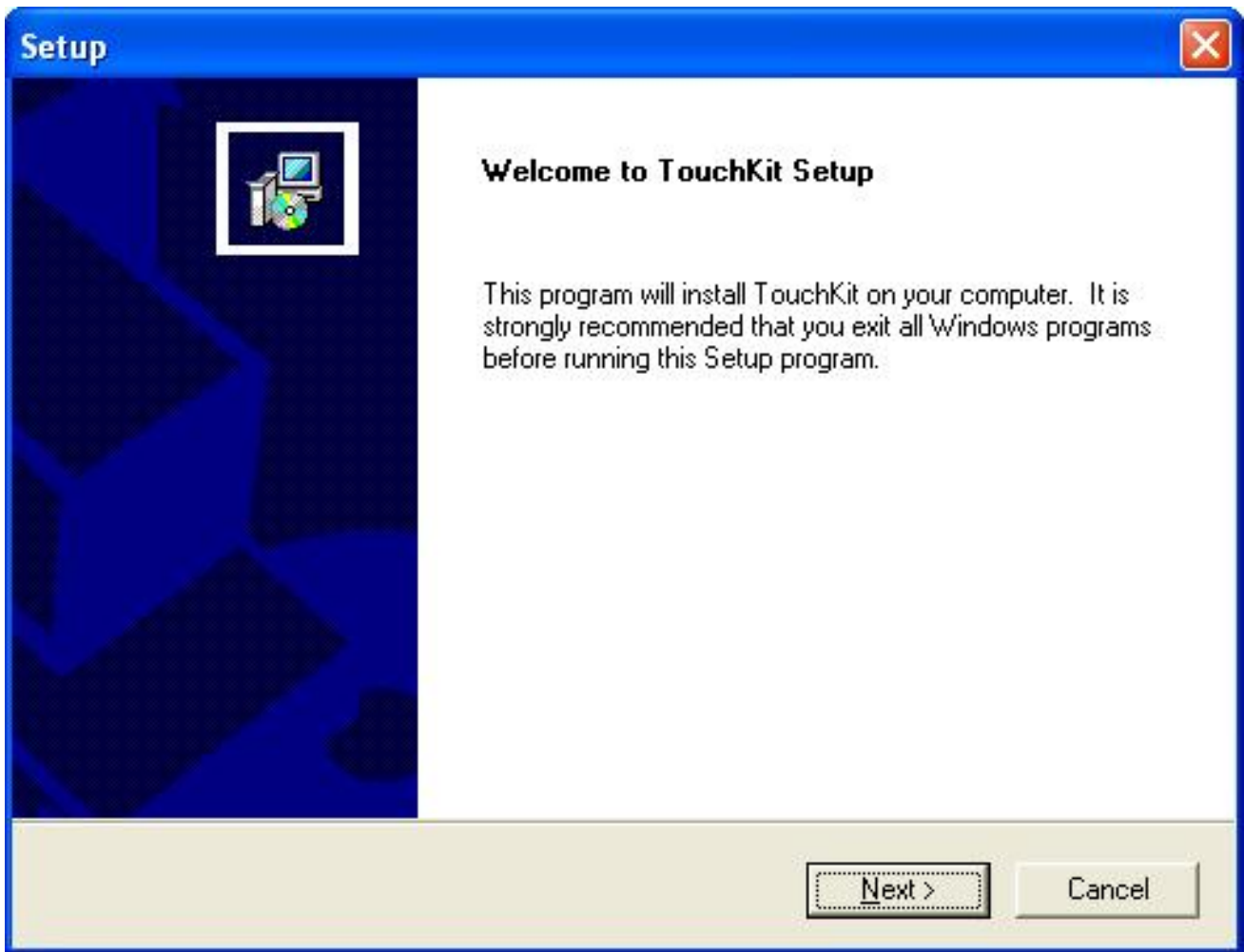

**When the setup screen appears then to select "Next" step.**

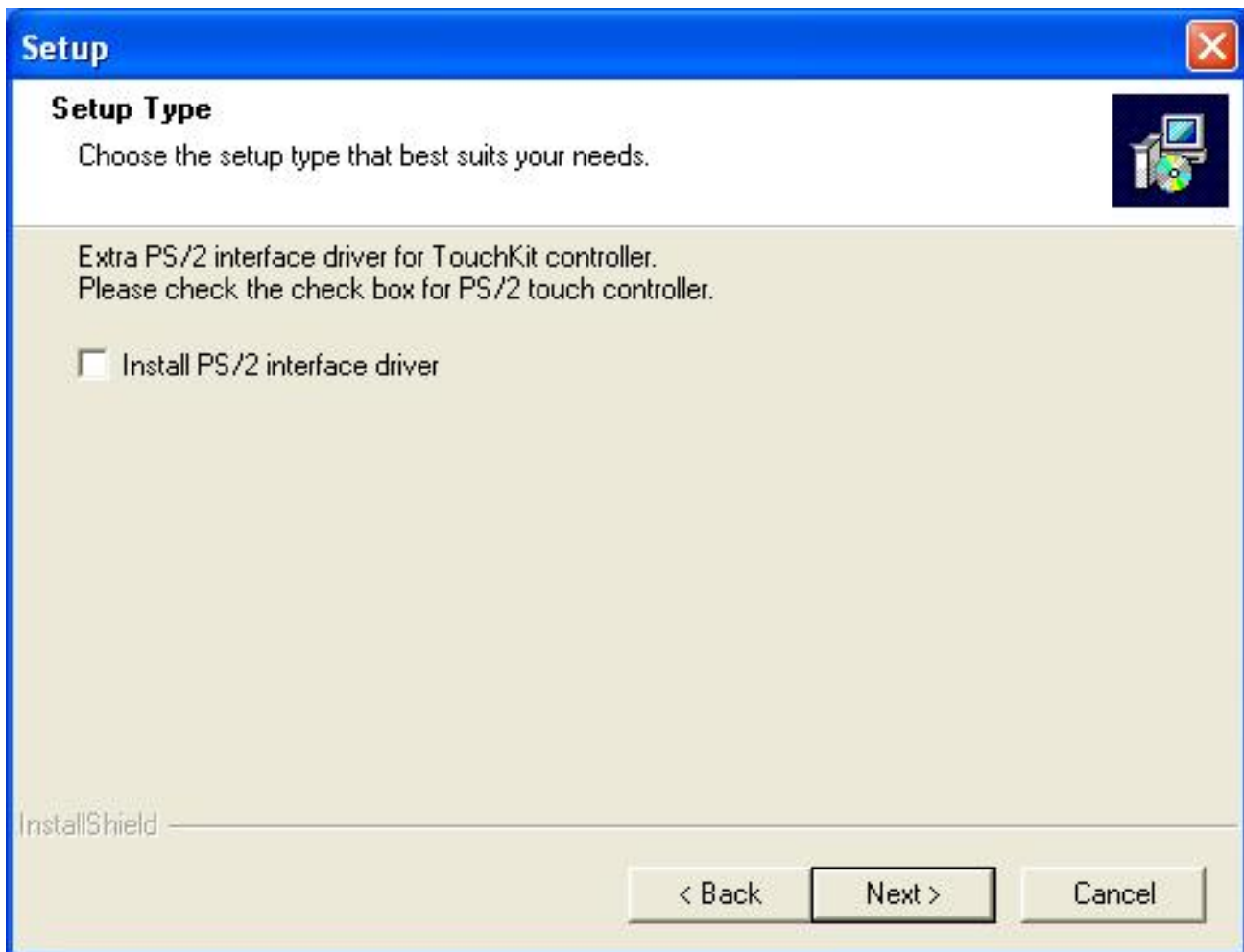

**When the setup screen appears then to select "Next" step.**

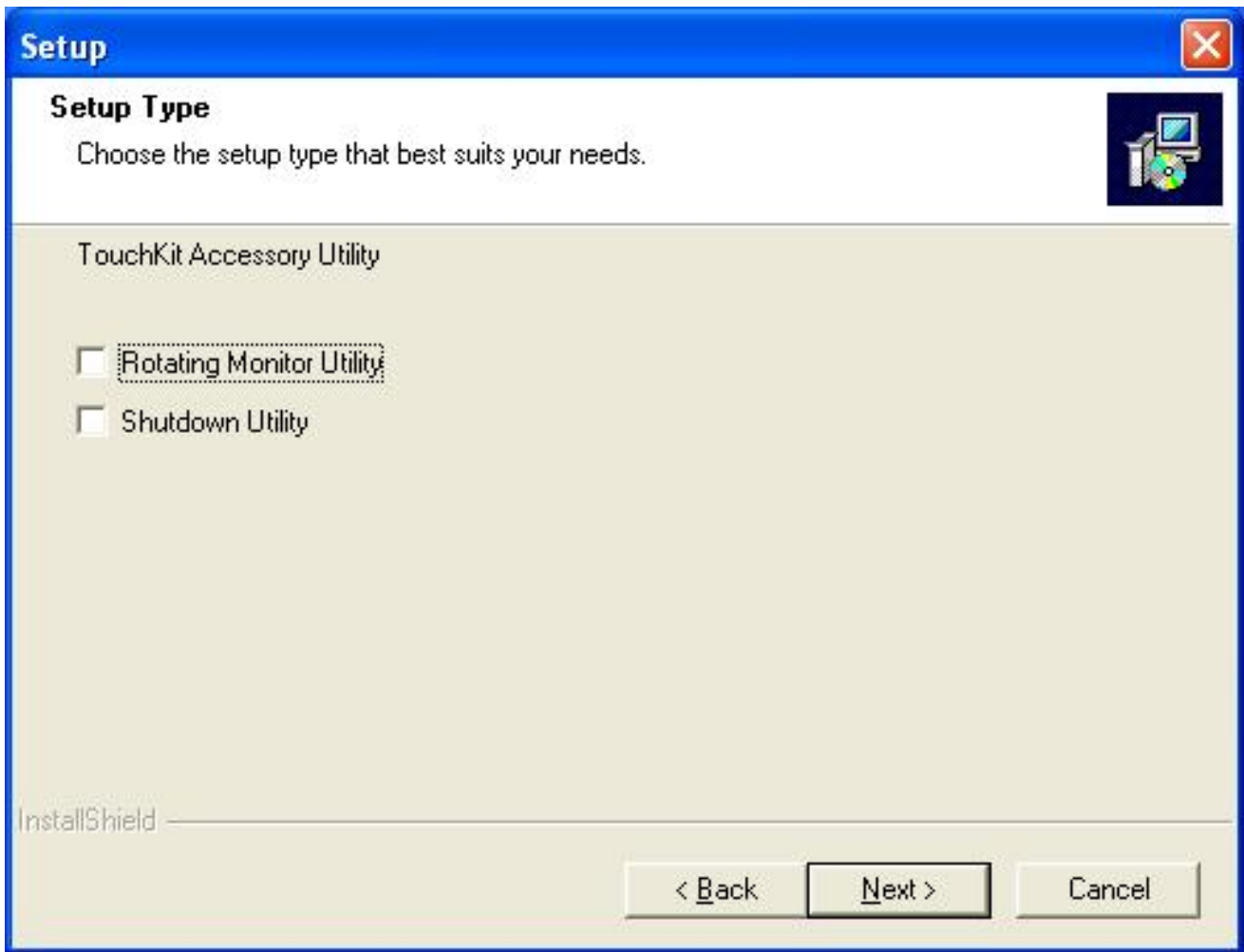

**When the setup screen appears then to select "Next" step.**

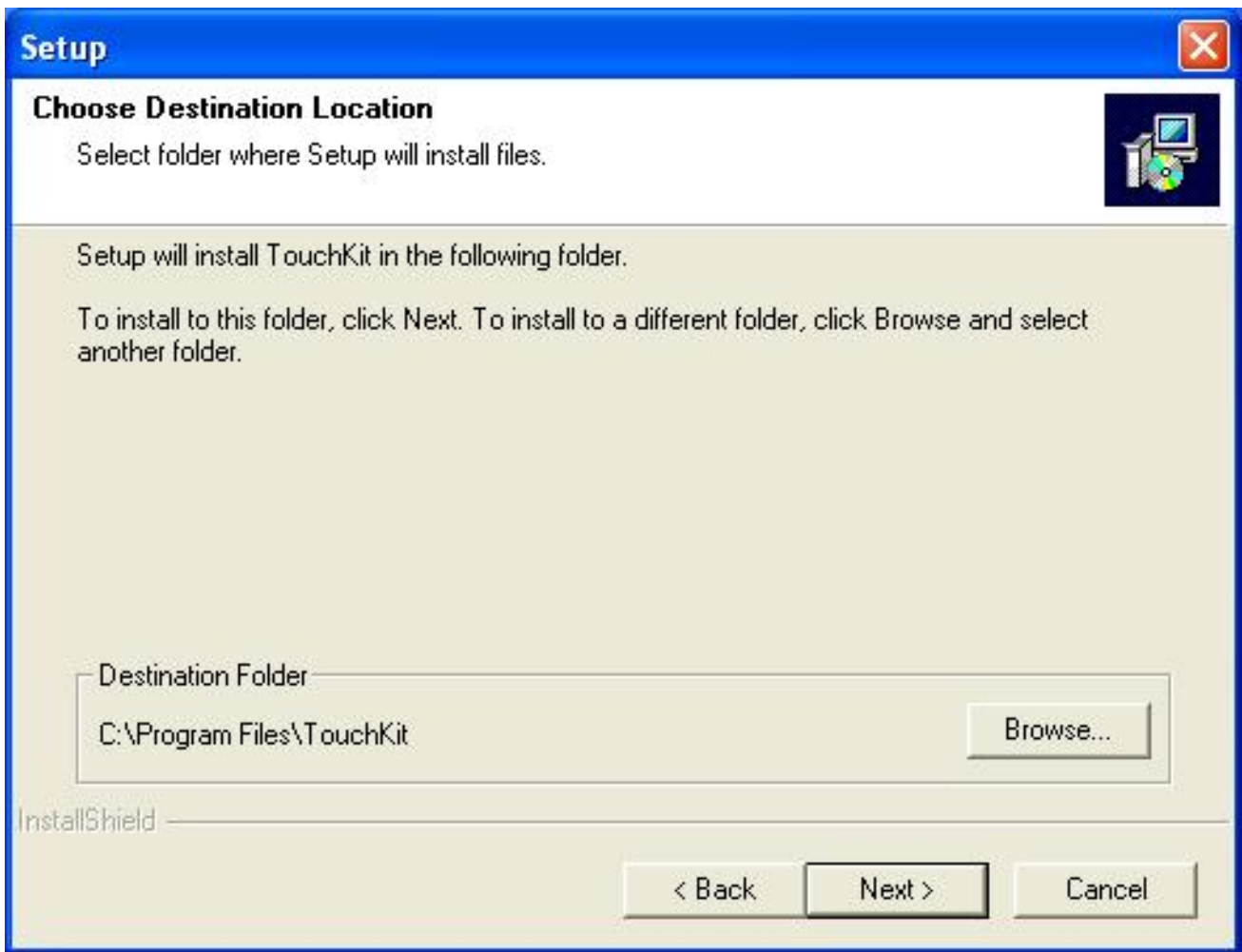

**When the setup screen appears then to select "Next" step.**

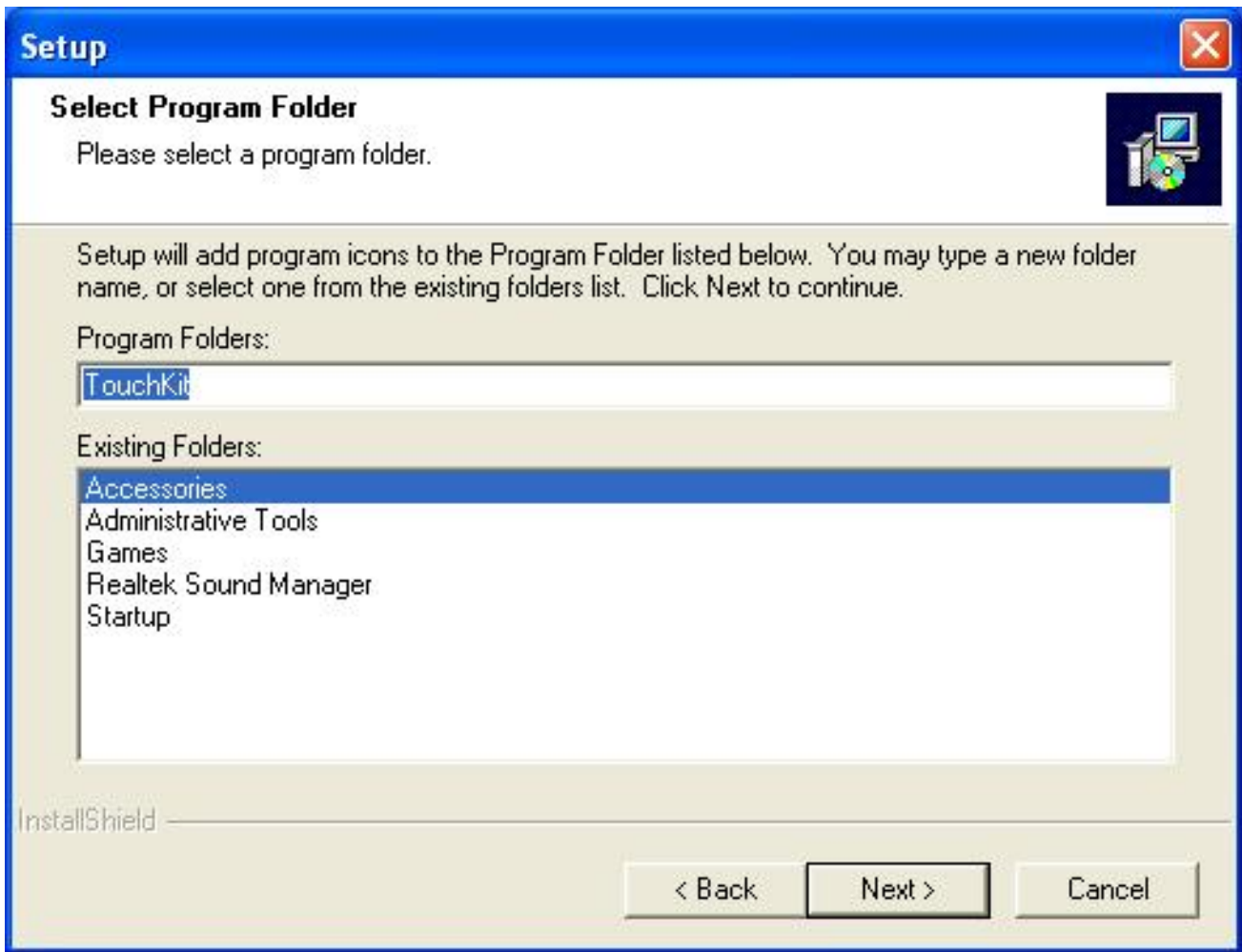

**When the setup screen appears then to select "Next" step.**

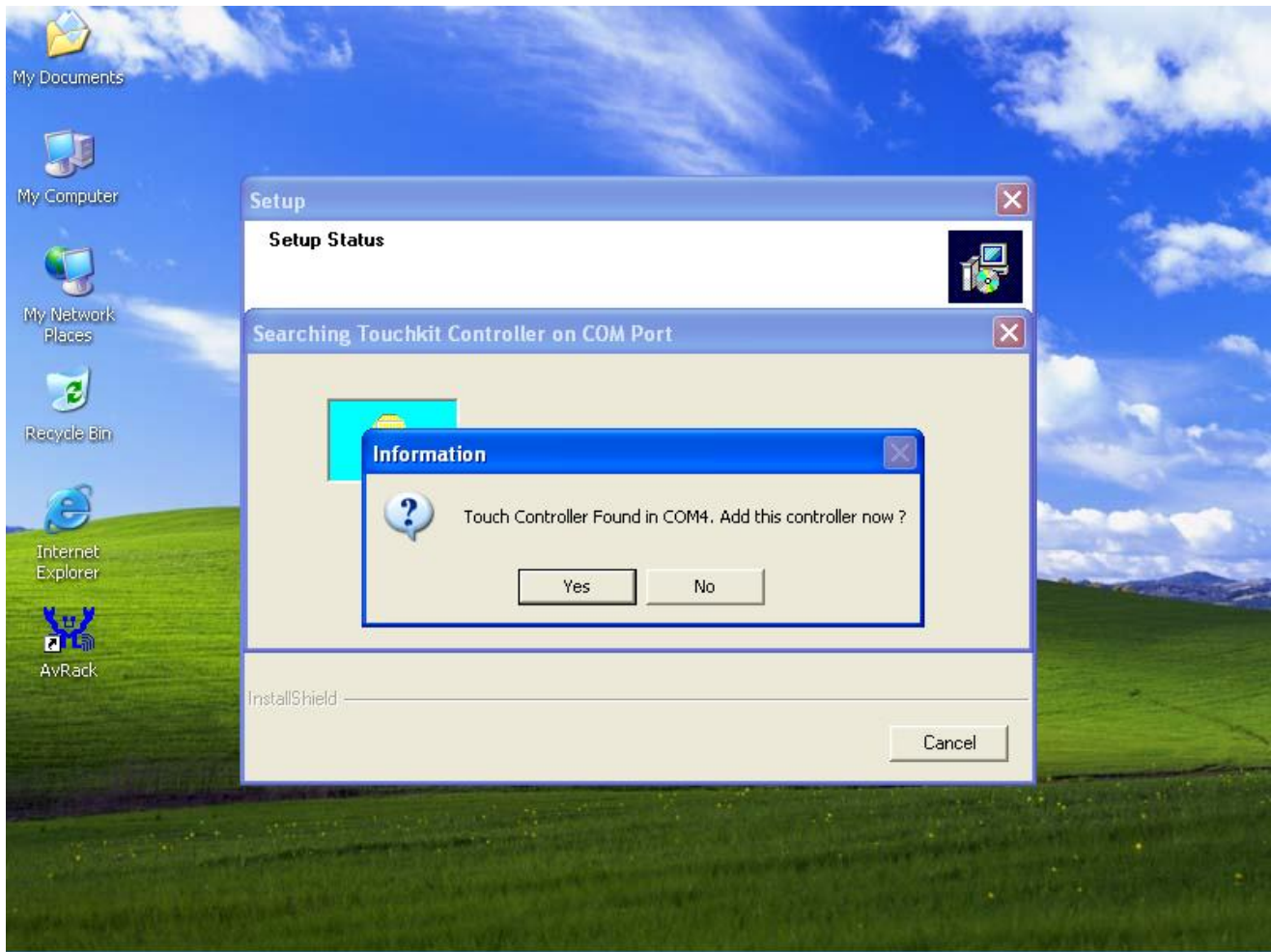

**When the setup screen appears then to select “ YES”.**

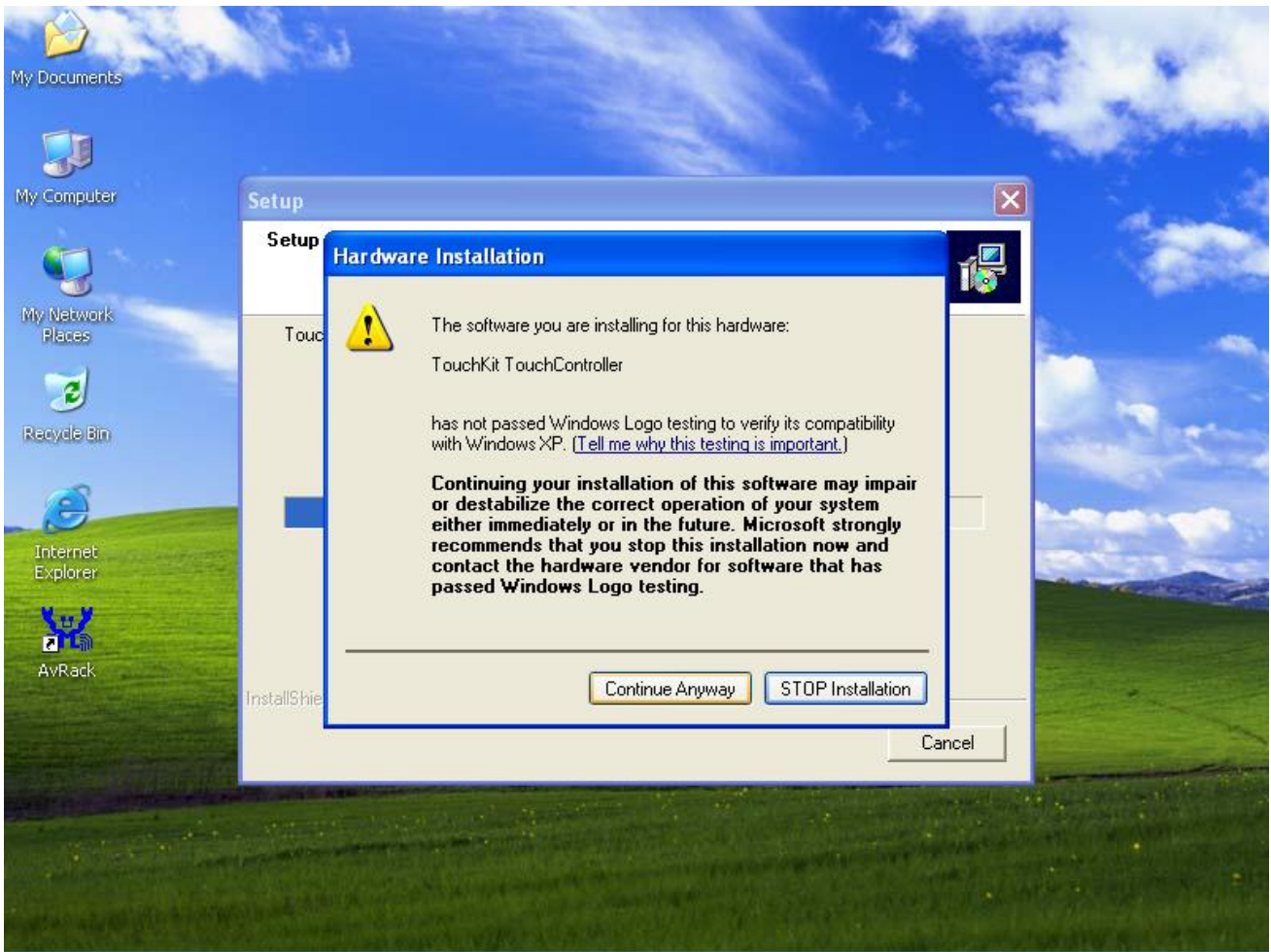

When the setup window appear then to select the “Continue Anyway”.



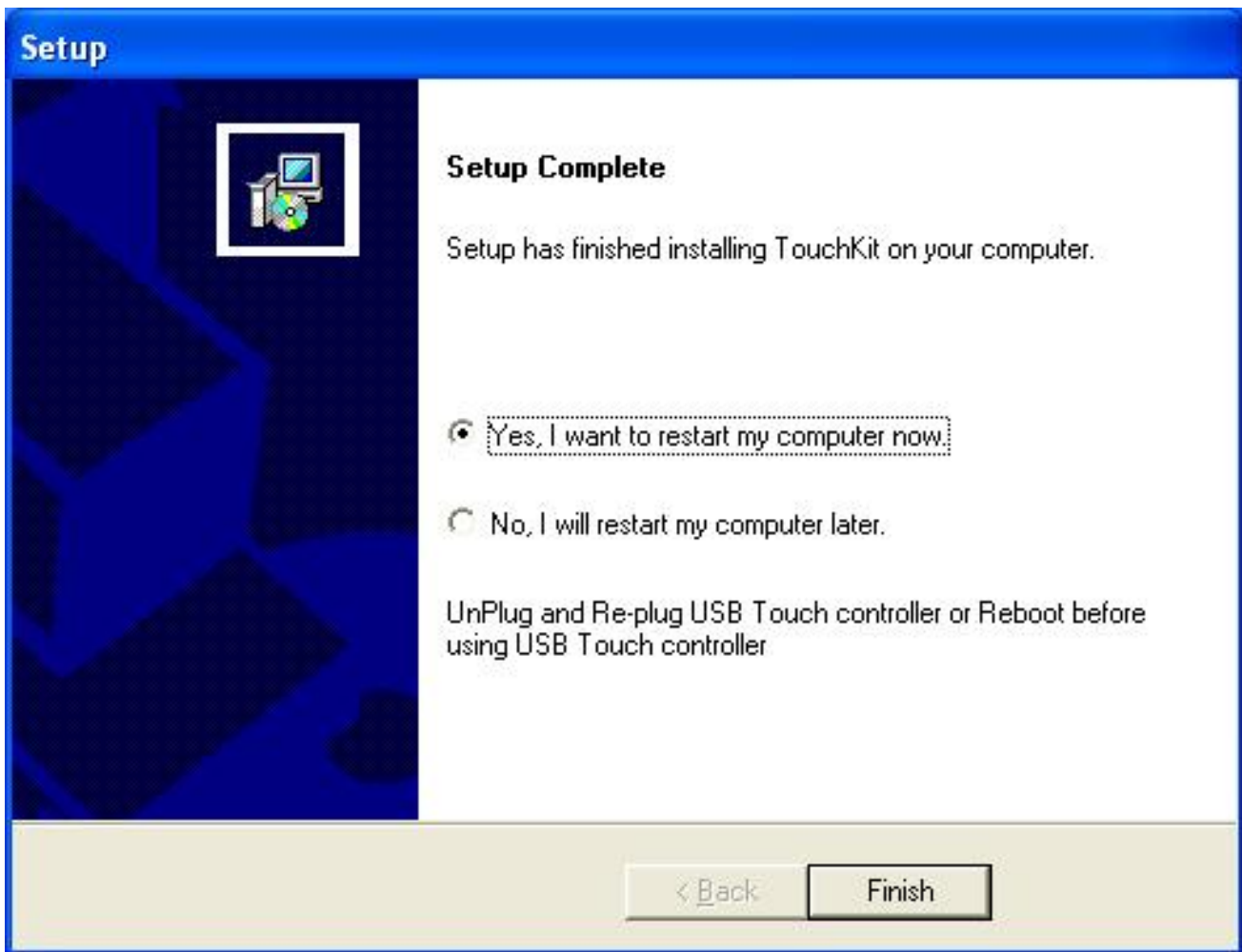

**After installation**

**System will require reboot**

**select “ YES”**



**When first time complete Touch installation, require processing the cursor accuracy calibration, Search for the Touchset utility shortcut on the desktop and select Touchset utility to set up.**

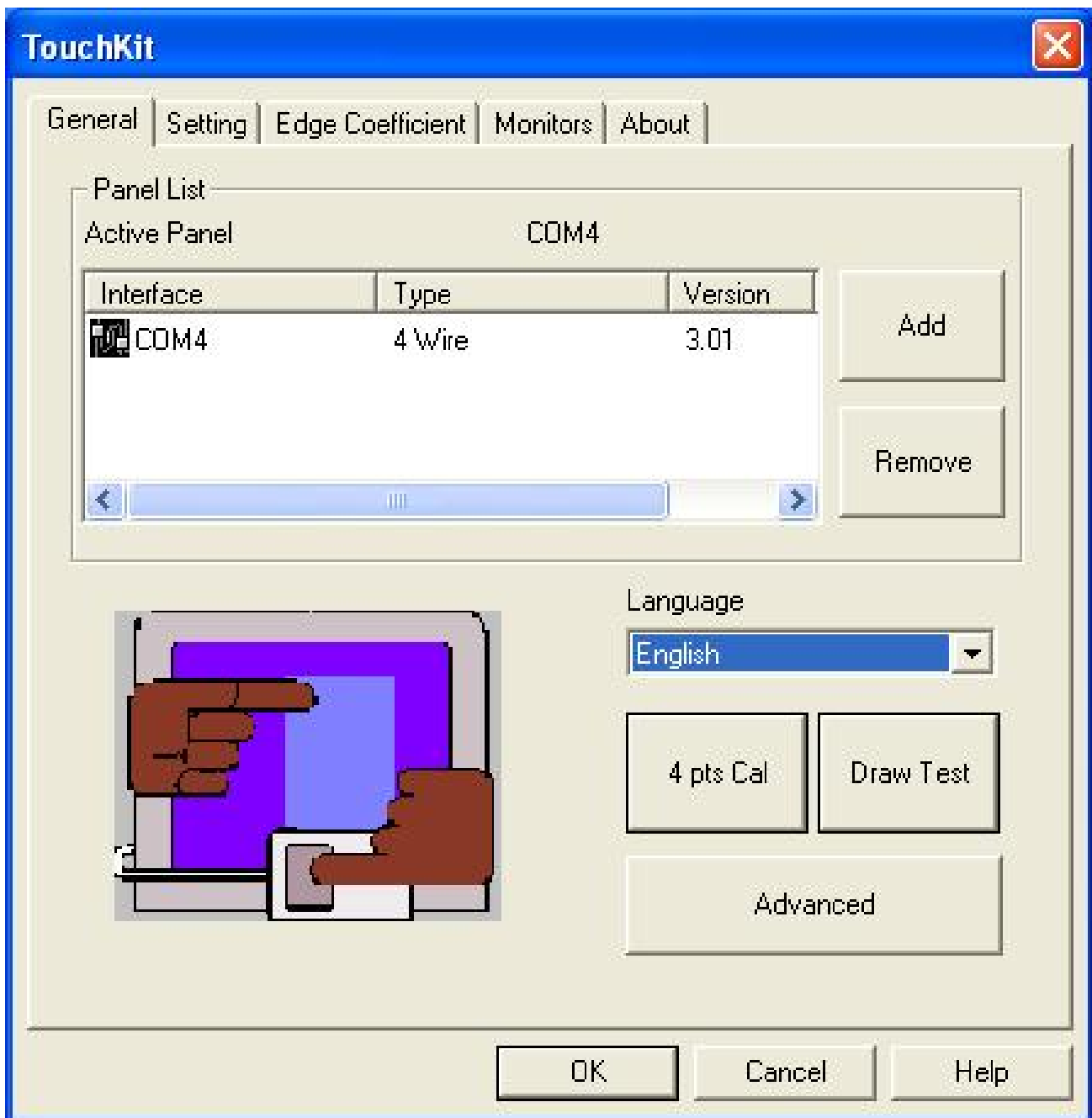

When configuration window appear, select the language which you desire.

(As above selected picture explanation)

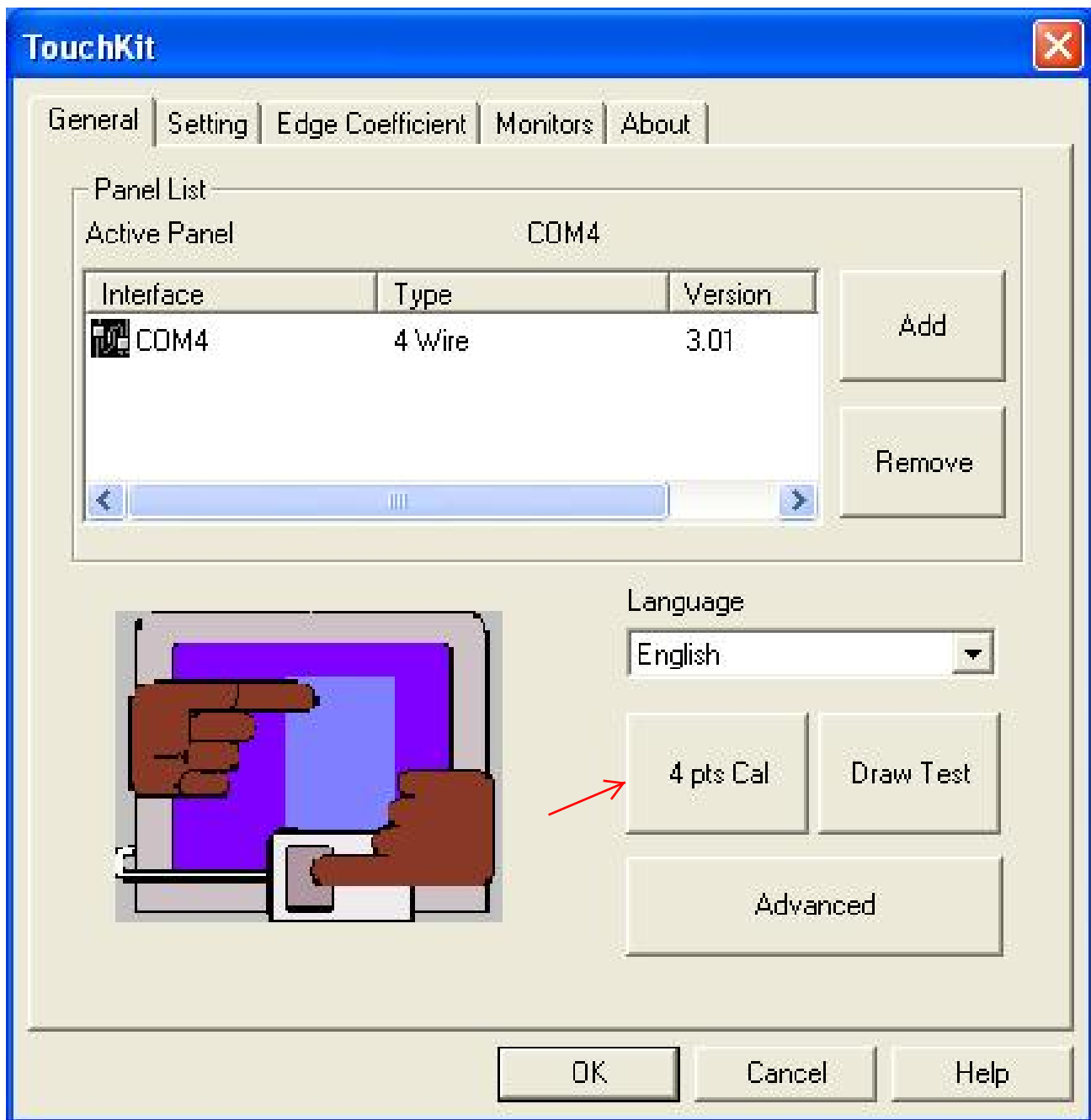

Then to select calibration function and select numbers of calibration point first (above picture shows select by 4 numbers) next to click on calibrate button.



**The screen will shows as above picture, use the Touch pen to point on dot to align the cursor, if the actual alignment has too much difference then the system will skip back to previous screen and require calibration once again.**

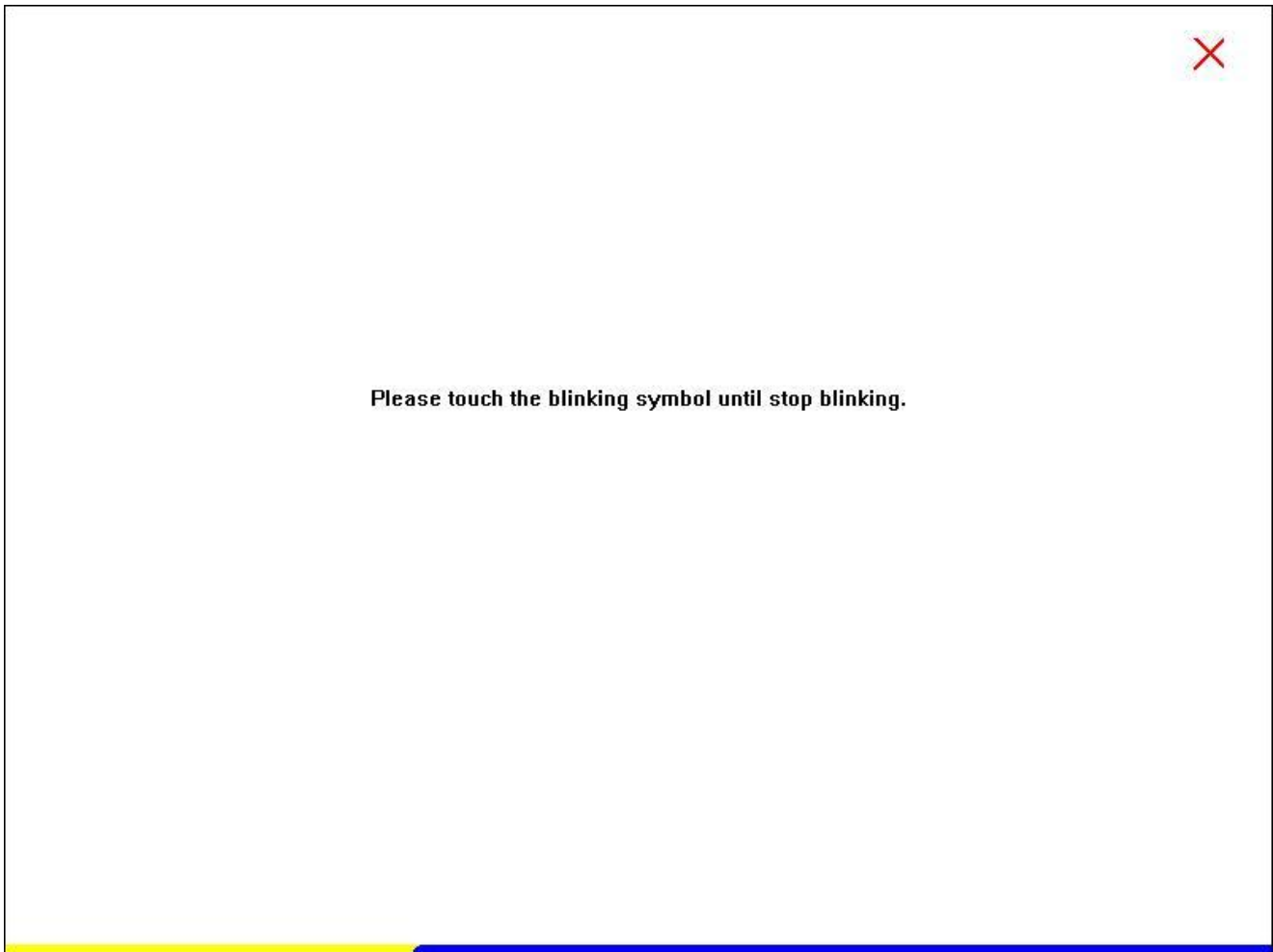

**The numbers of the calibration point shows on the screen will depend on the number you have set previously, after complete system will skip back to desktop (if the cursor still not accurate please repeat the calibration again).**

## IDE Drivers



Insert CD Rom and select "Driver & Manual" file folder.

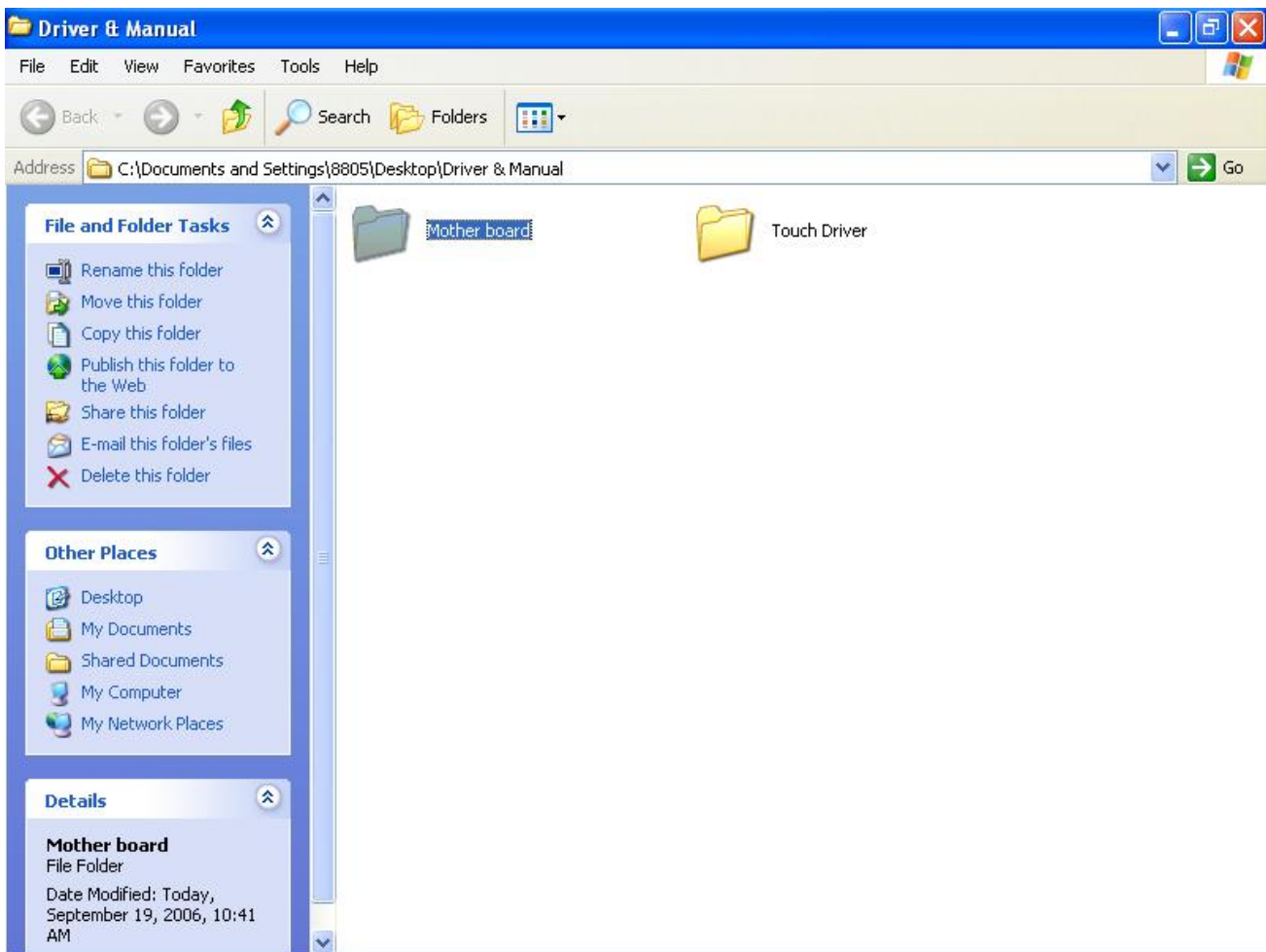

Select the "Mother board" folder.



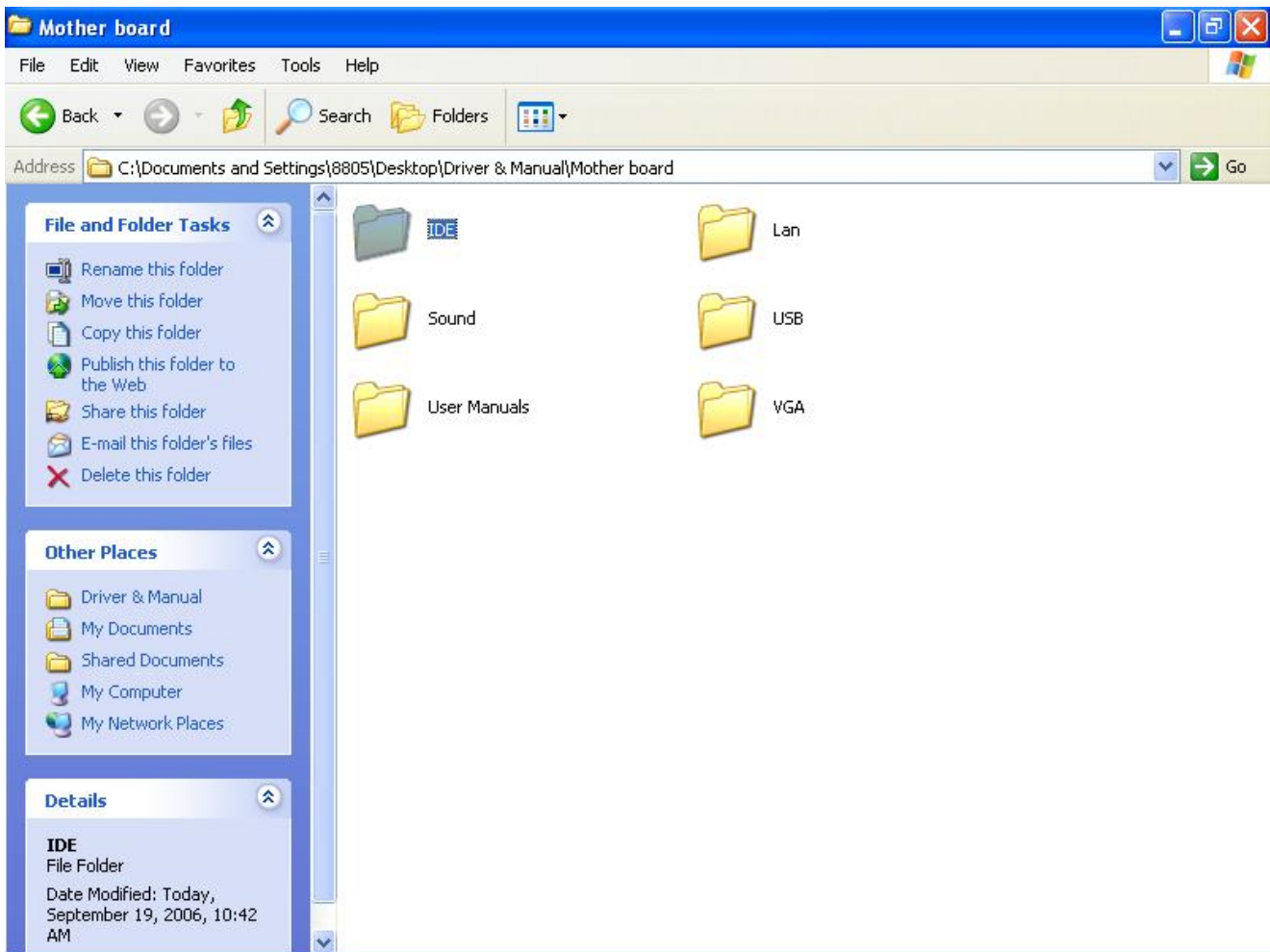

And select "IDE" folder.

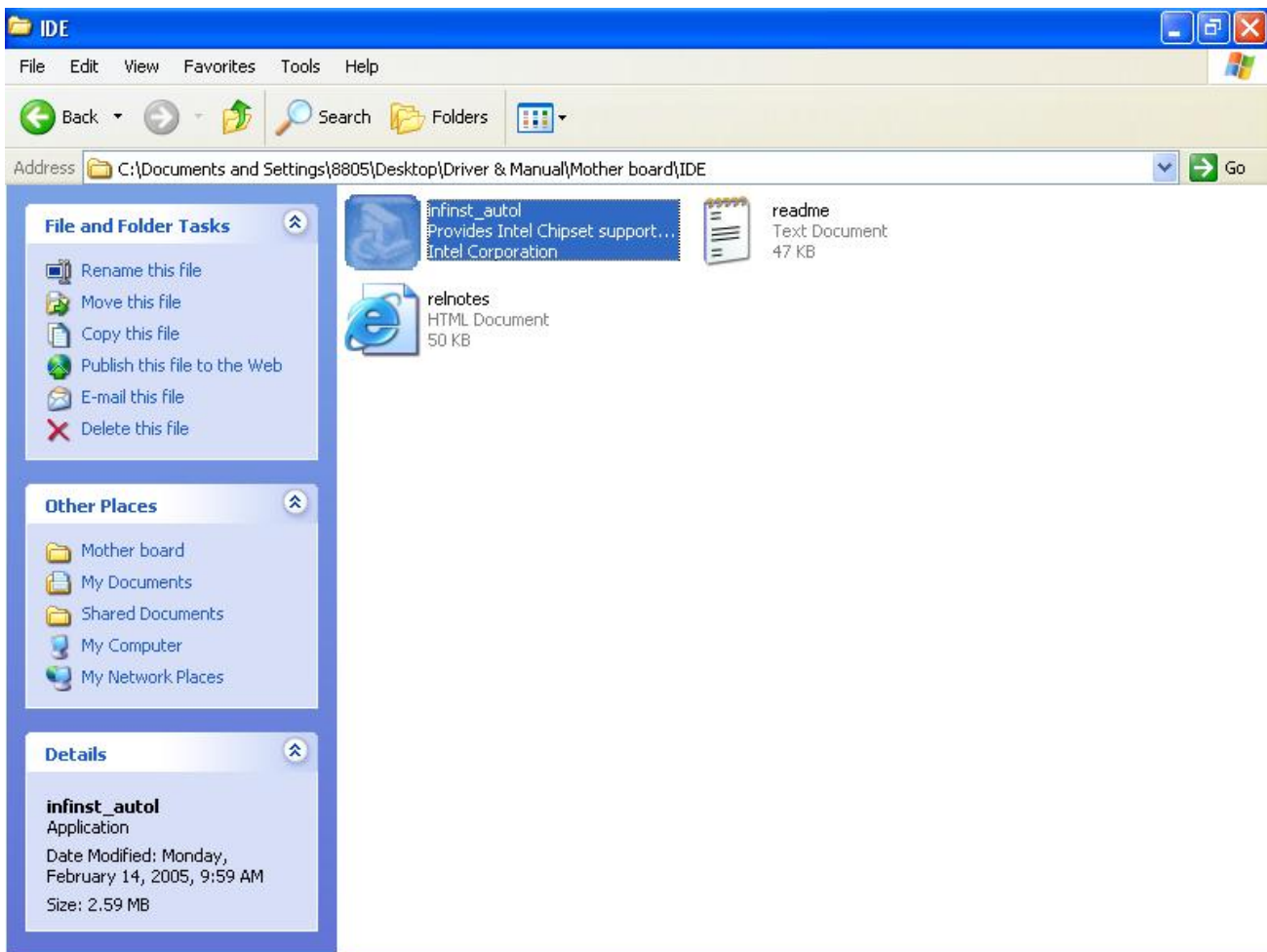

Access the "infinst\_autol.exe".

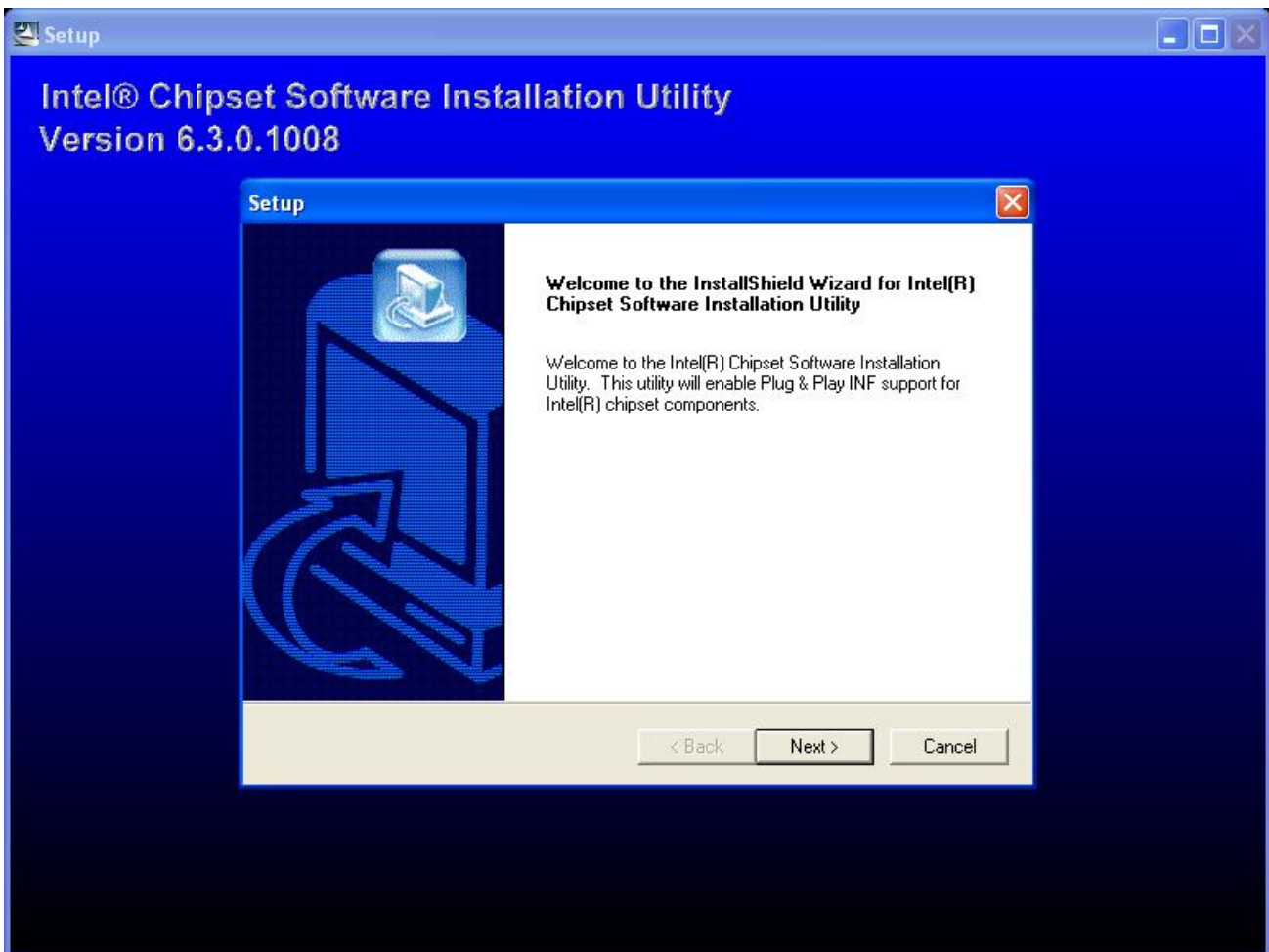

**When the setup screen appears then to select "Next" step.**

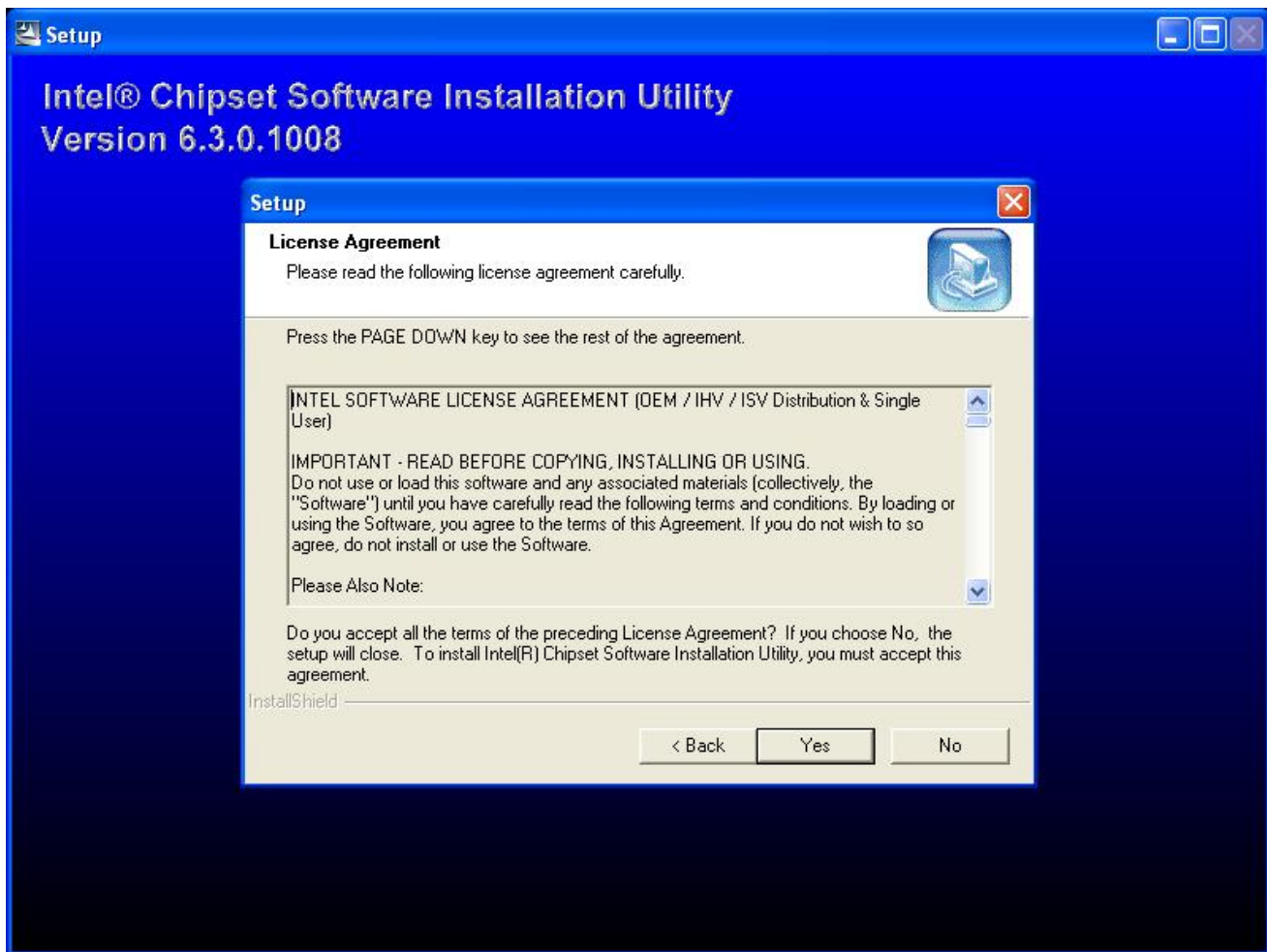

Select "Yes" to accept authorization agreement.

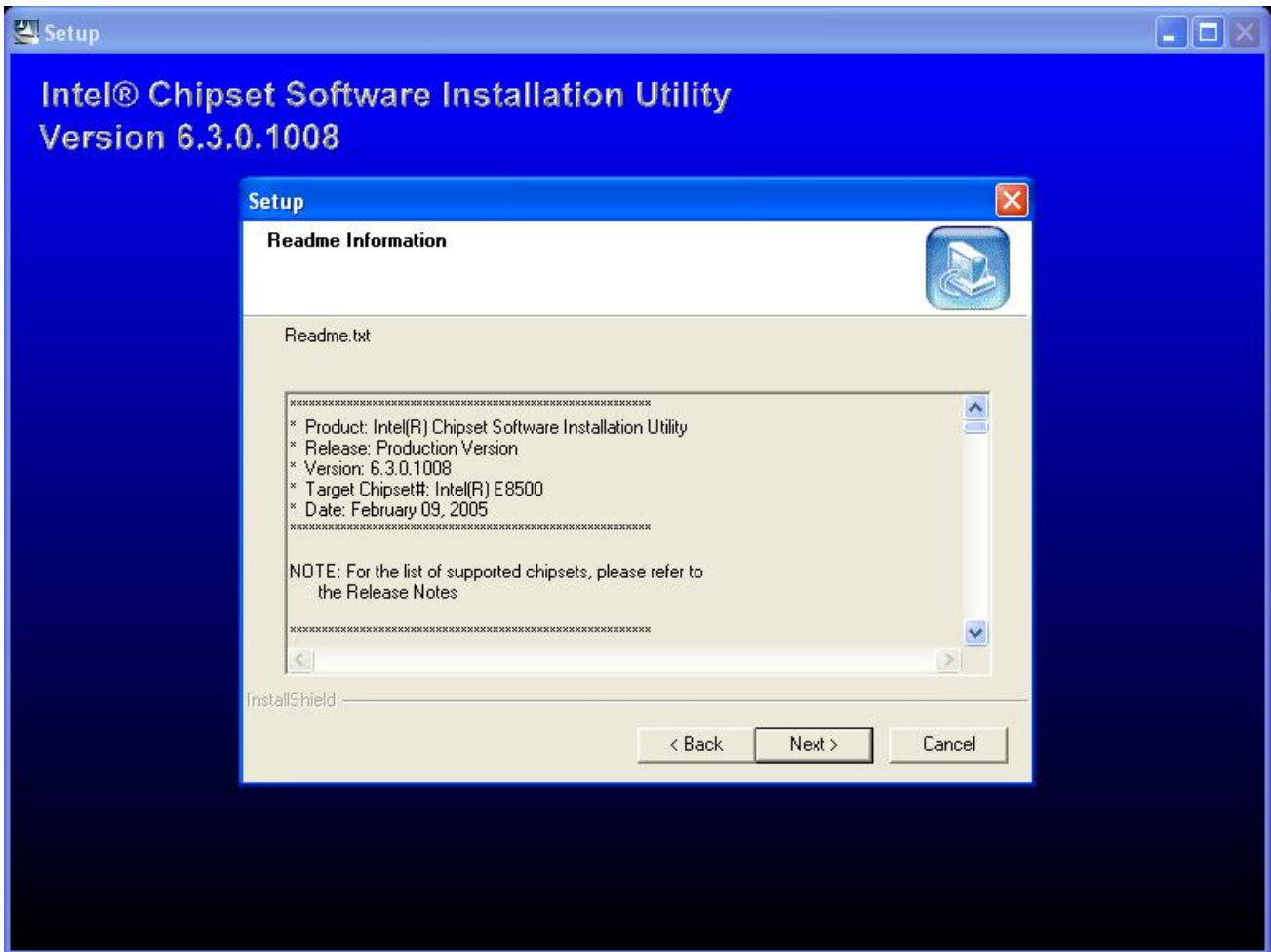

Select "Next" step to accept the software understanding agreement.

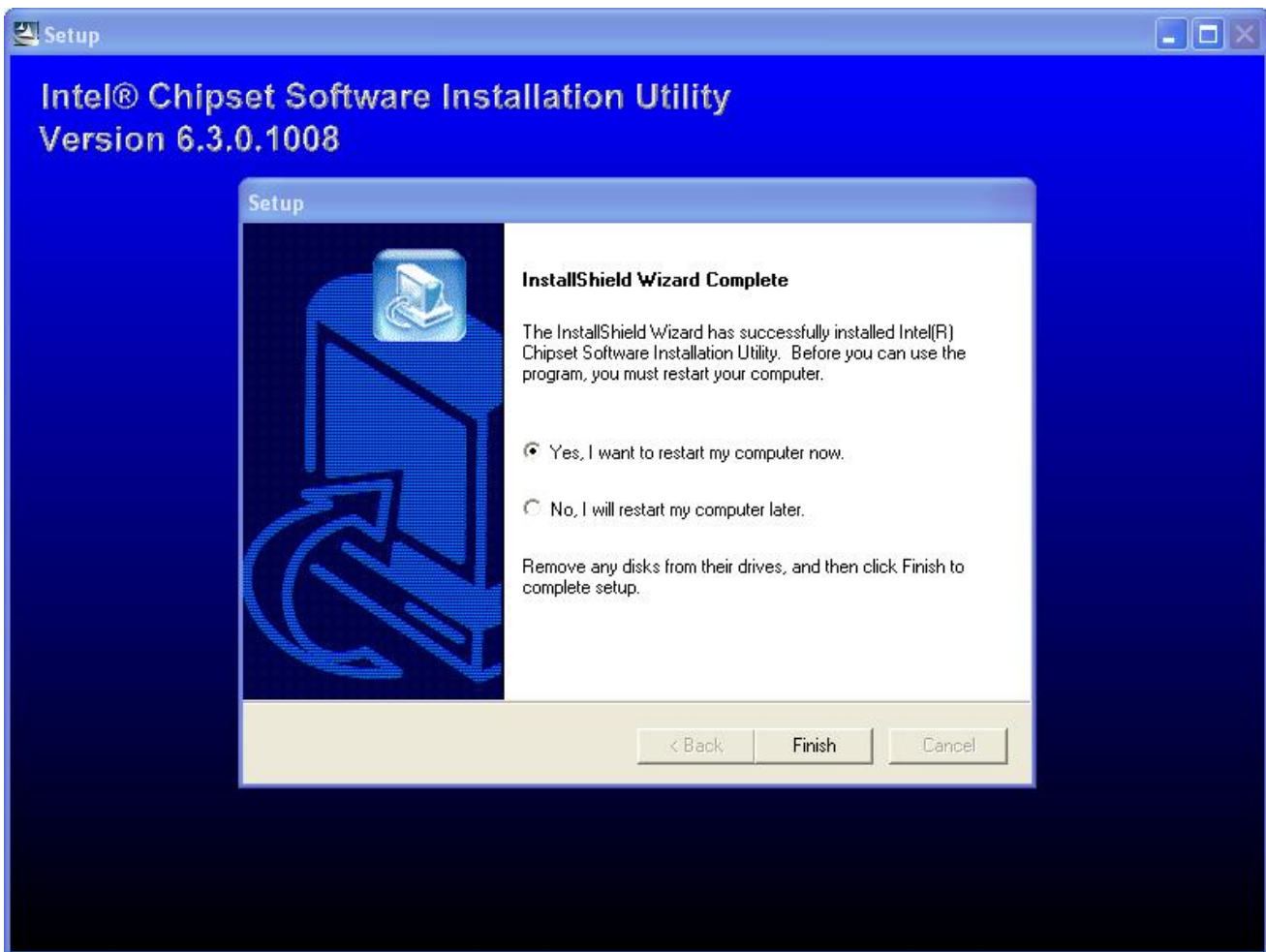

**After installation**

**System will require reboot**

**select "YES"**

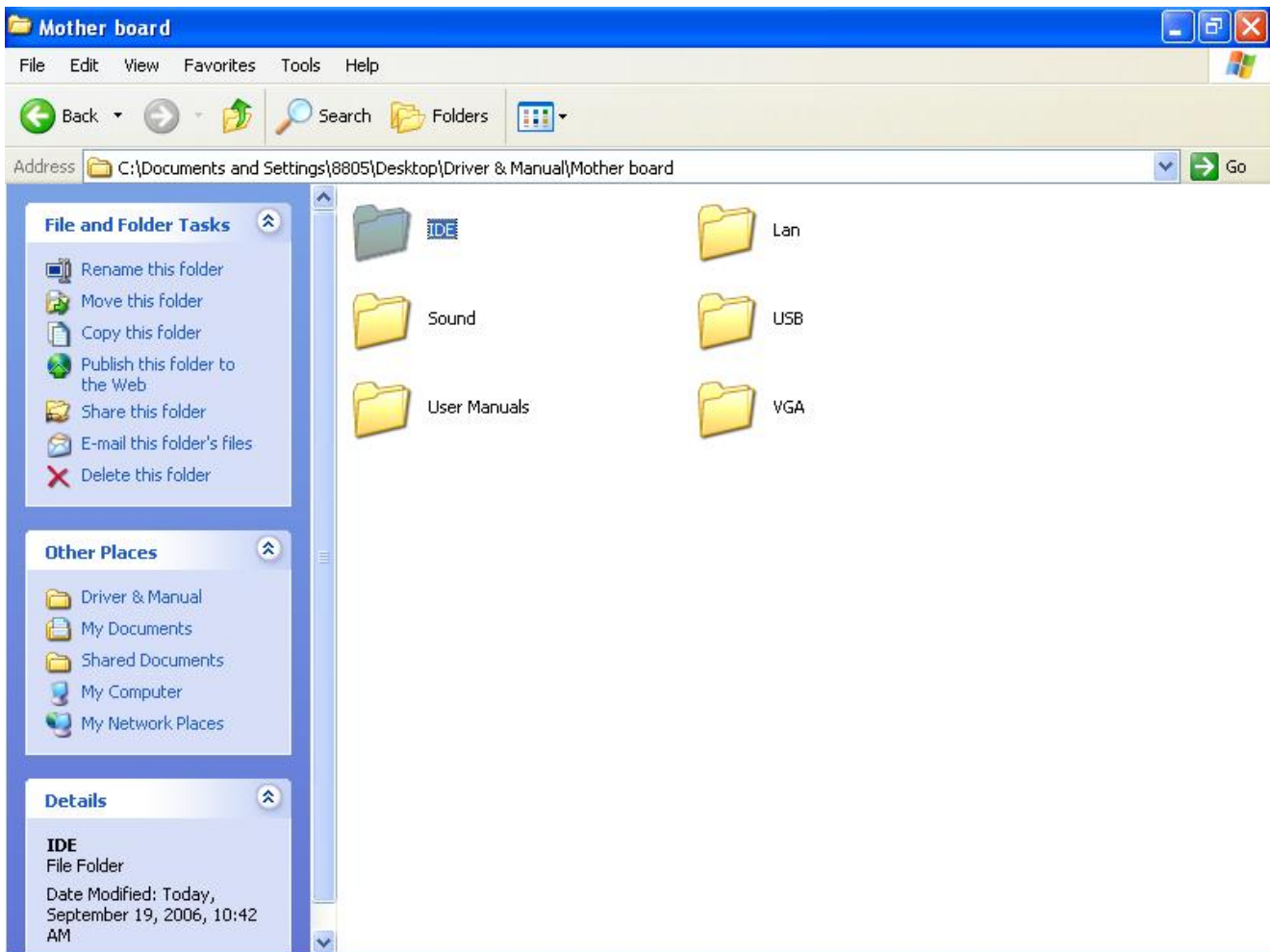

And select "IDE" folder.

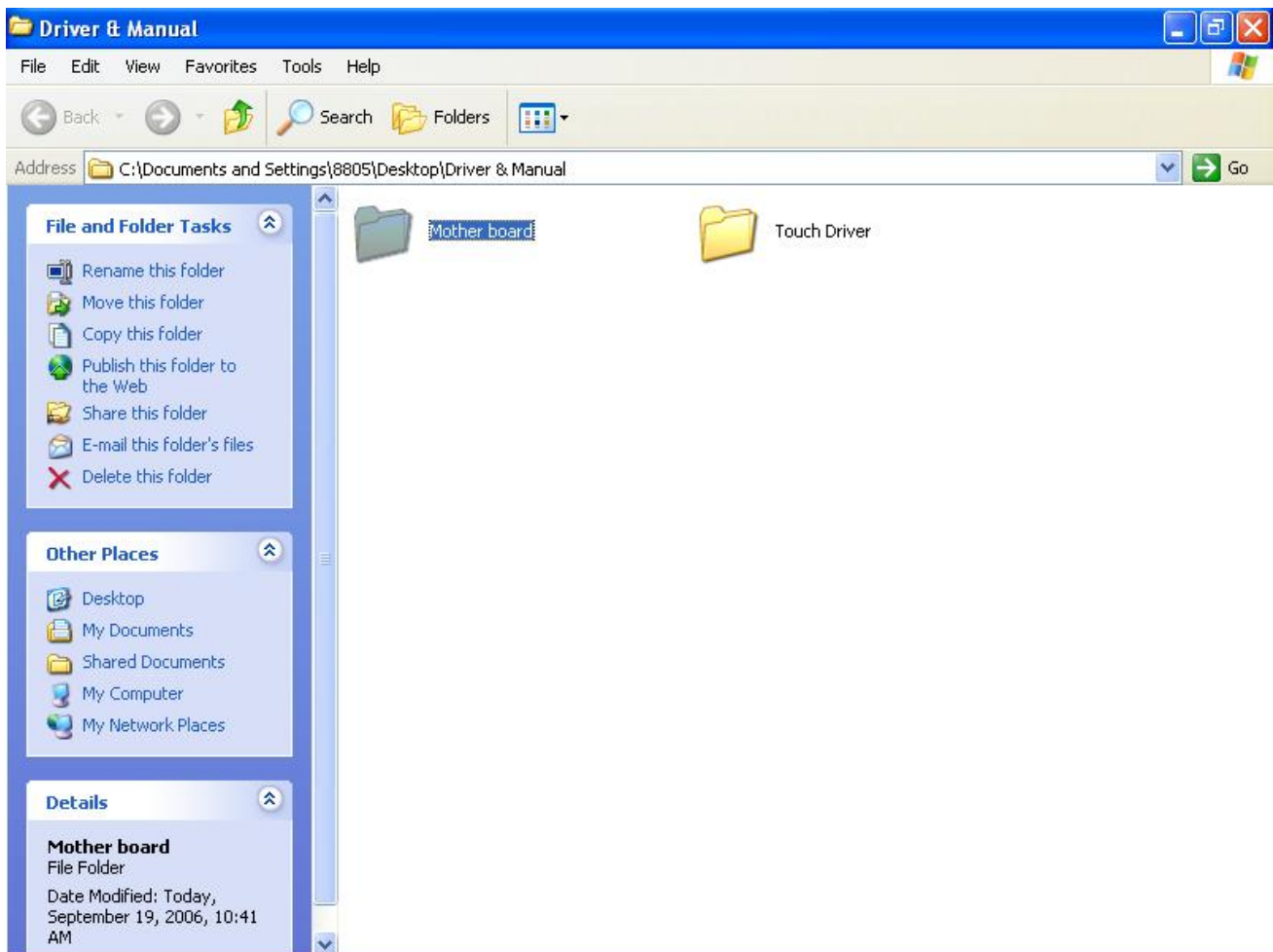

Select the "Mother board" folder.



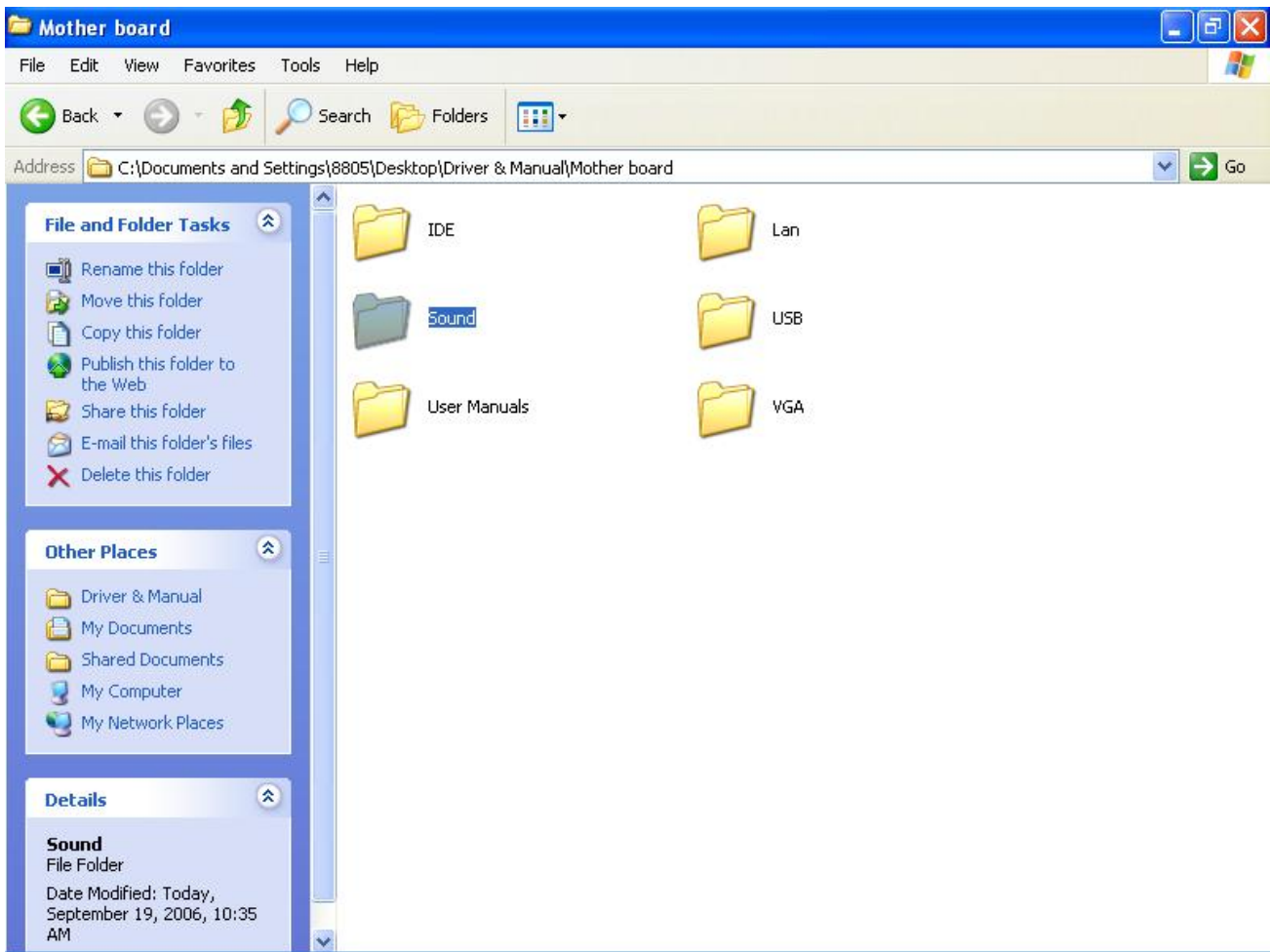

Select "Sound" folder.

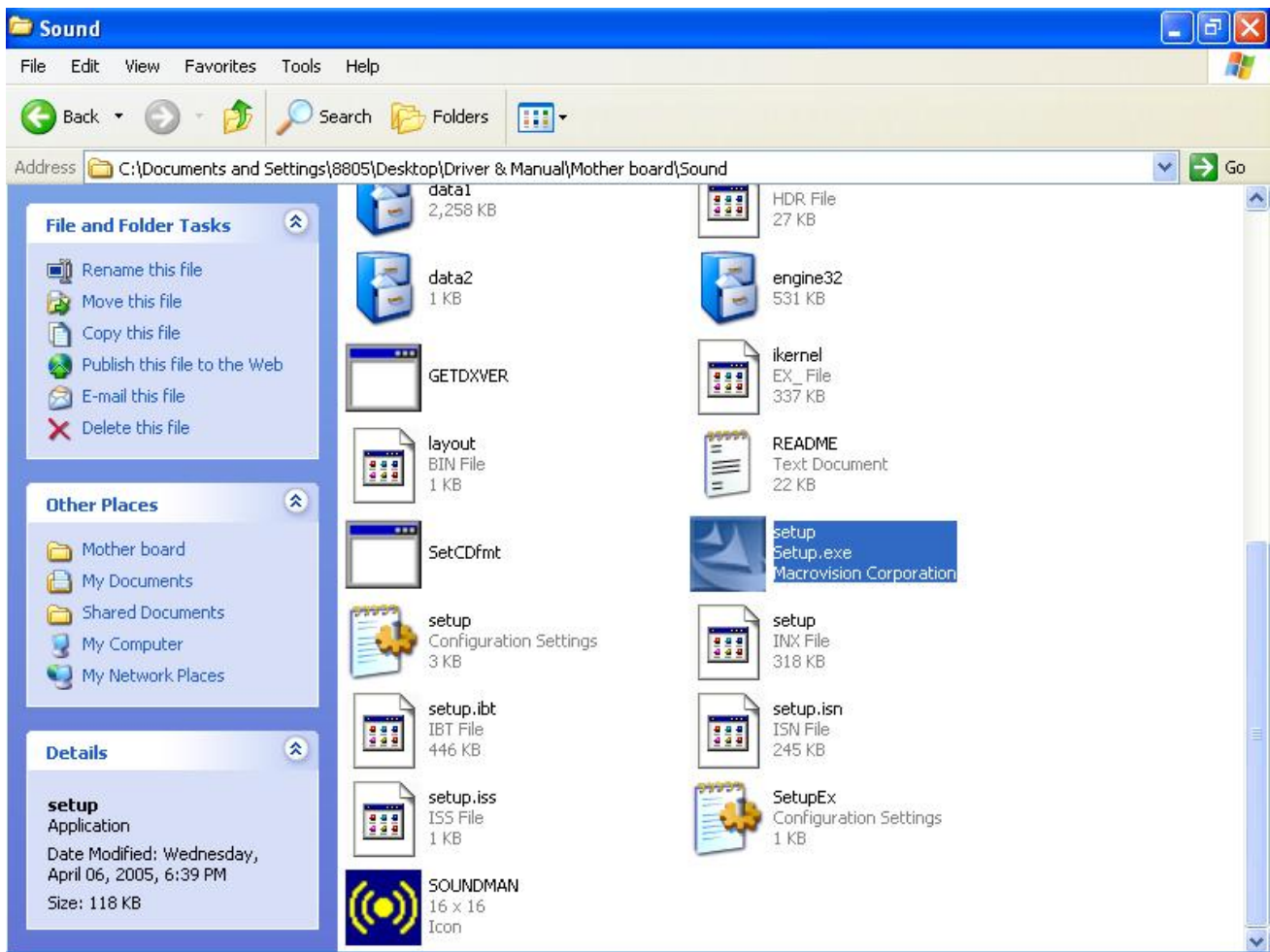

Access the "Setup".

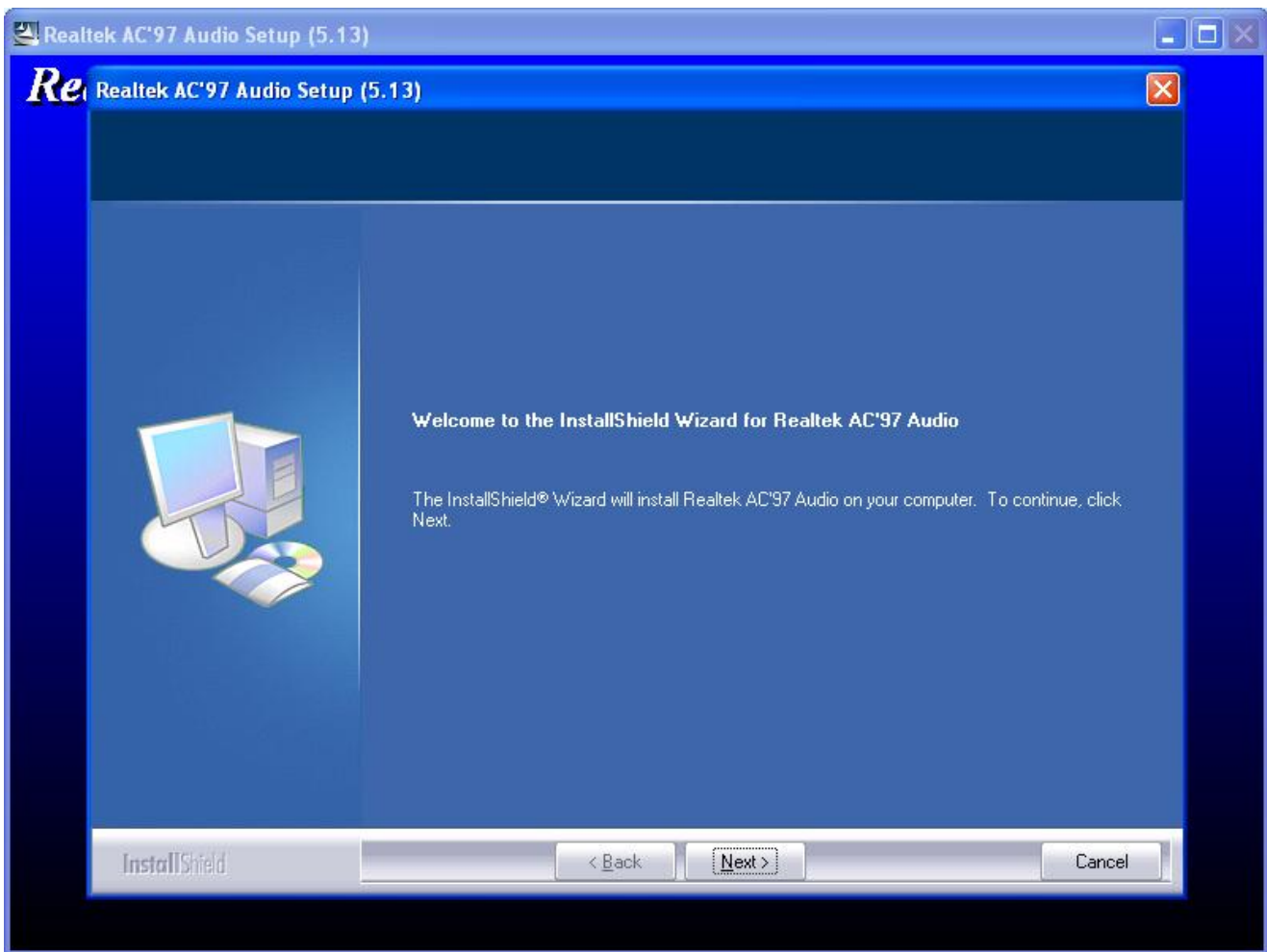

**When the setup screen appears click the "Next" step.**

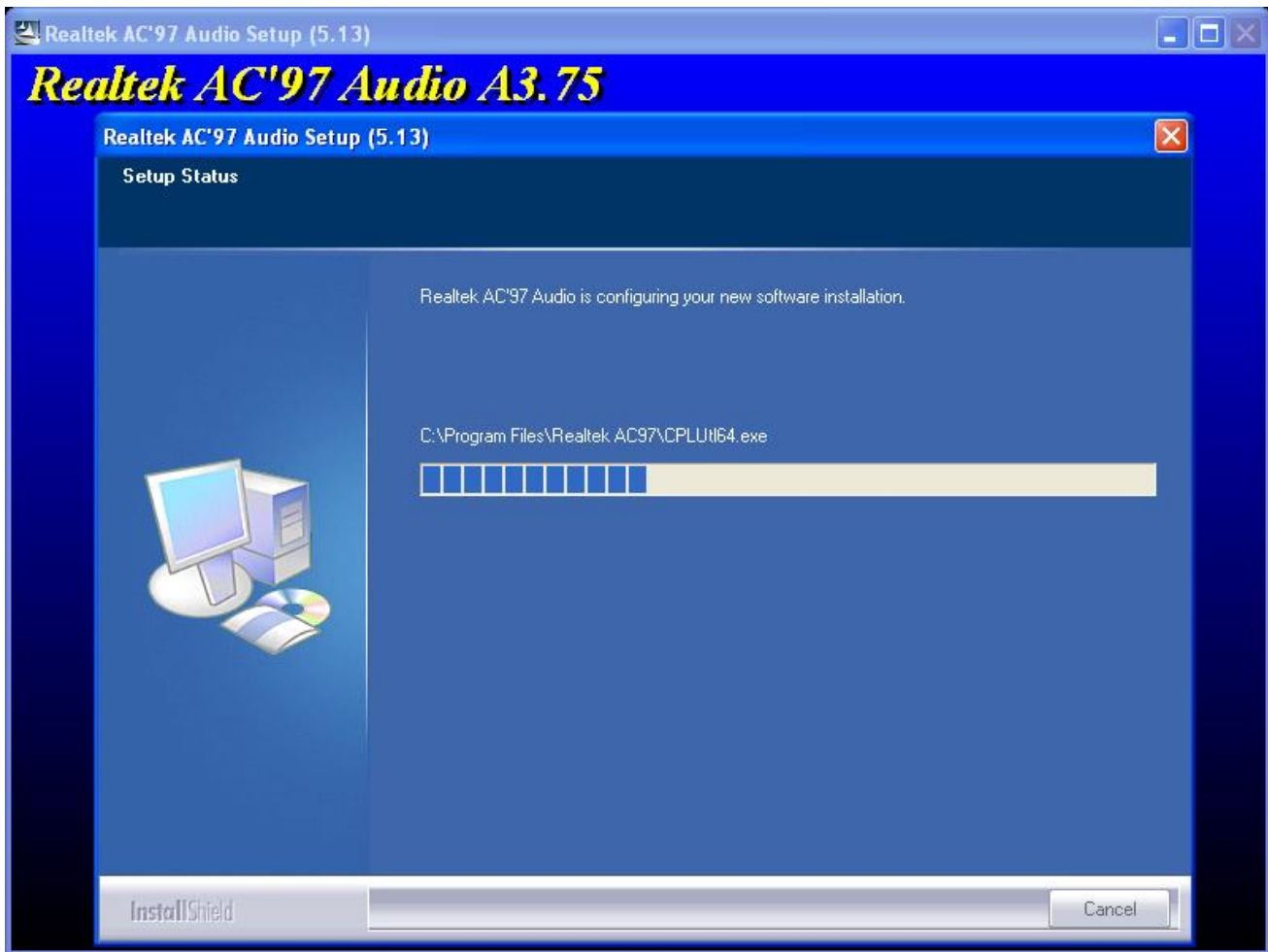

**Above screen shows the setup process.**

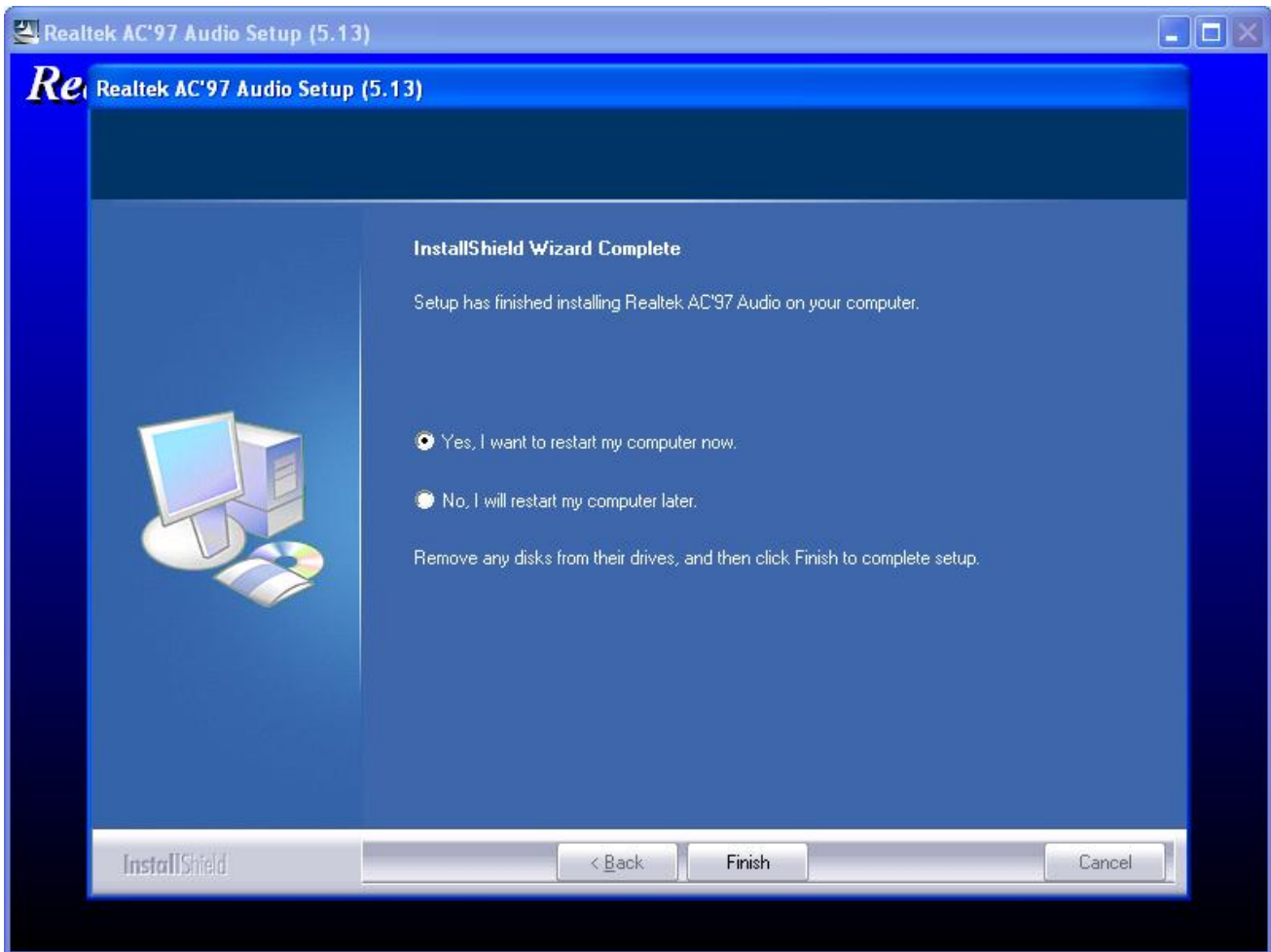

**After installation**

**System will require reboot**

**select "YES"**

## LAN Drivers

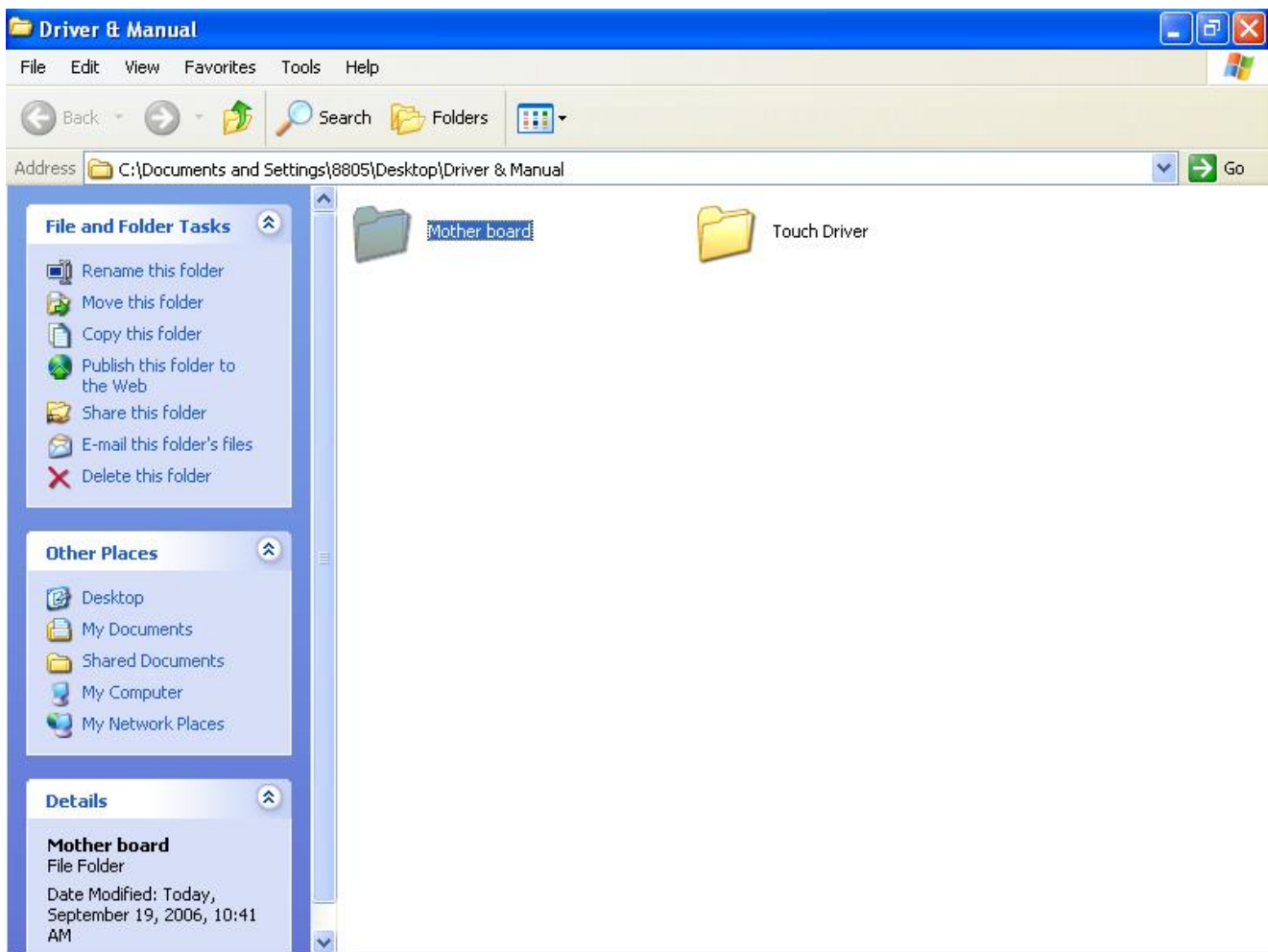

Select "Mother board" folder.

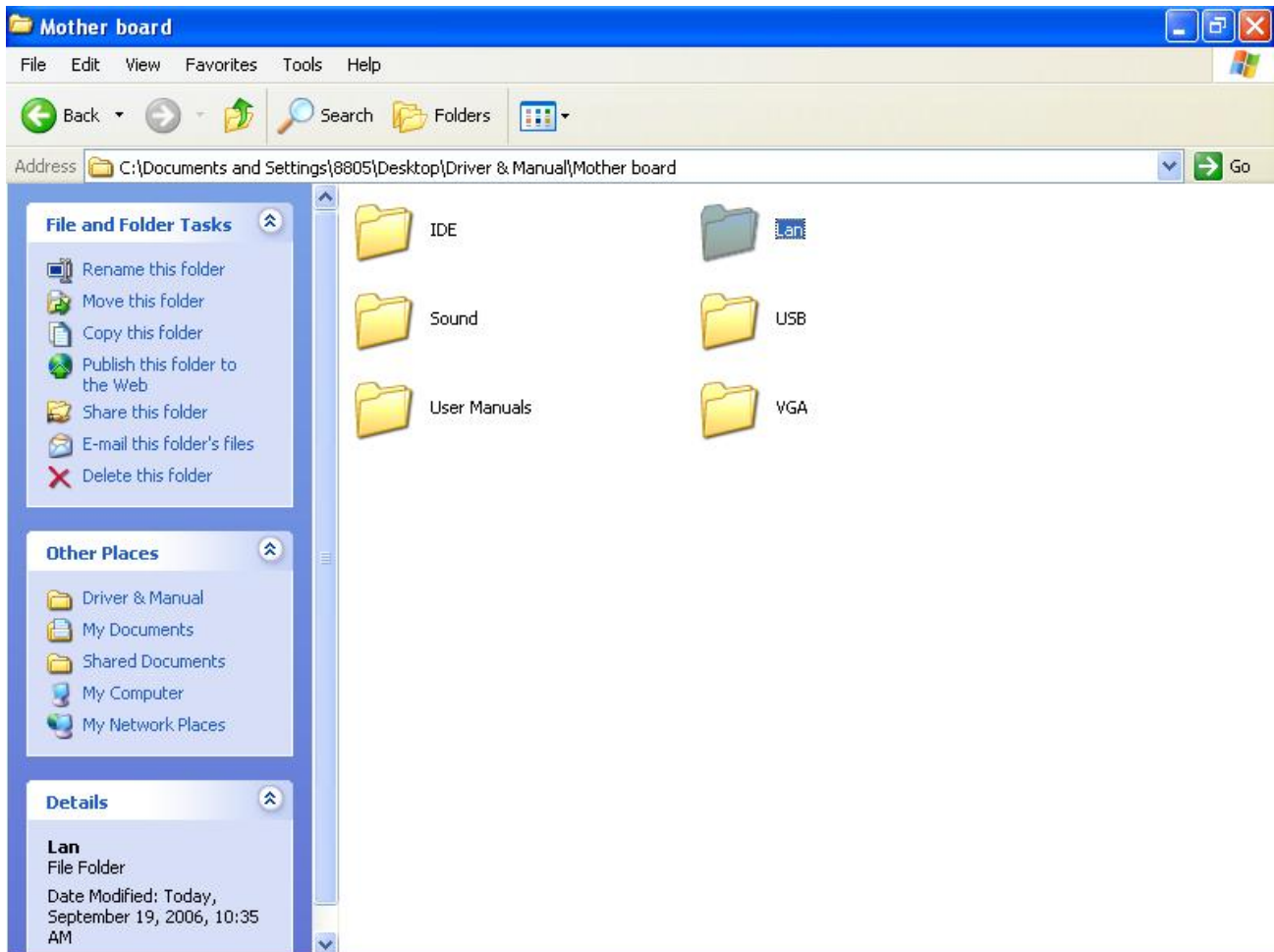

Select "LAN" folder.

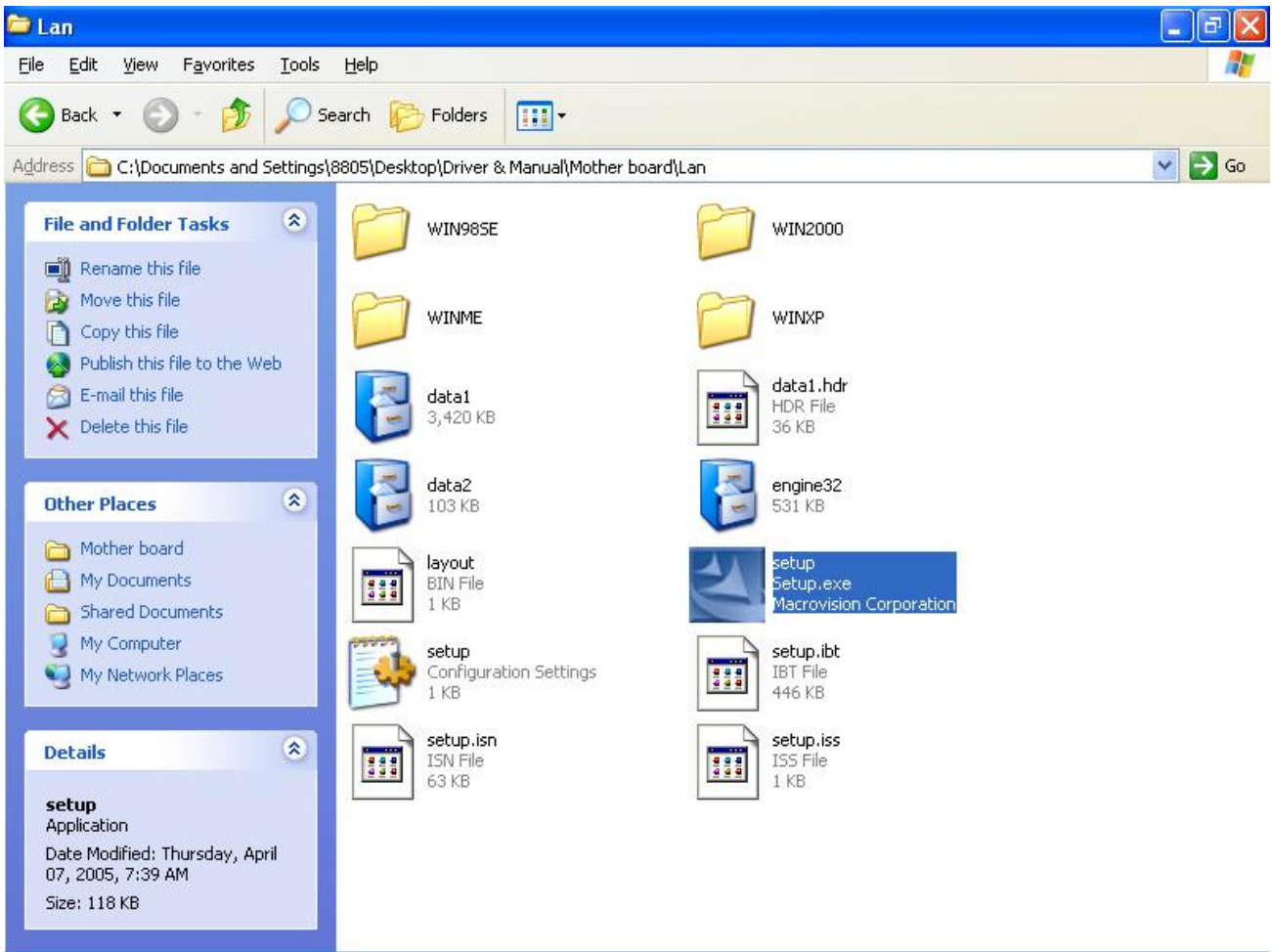

Access the "Setup".



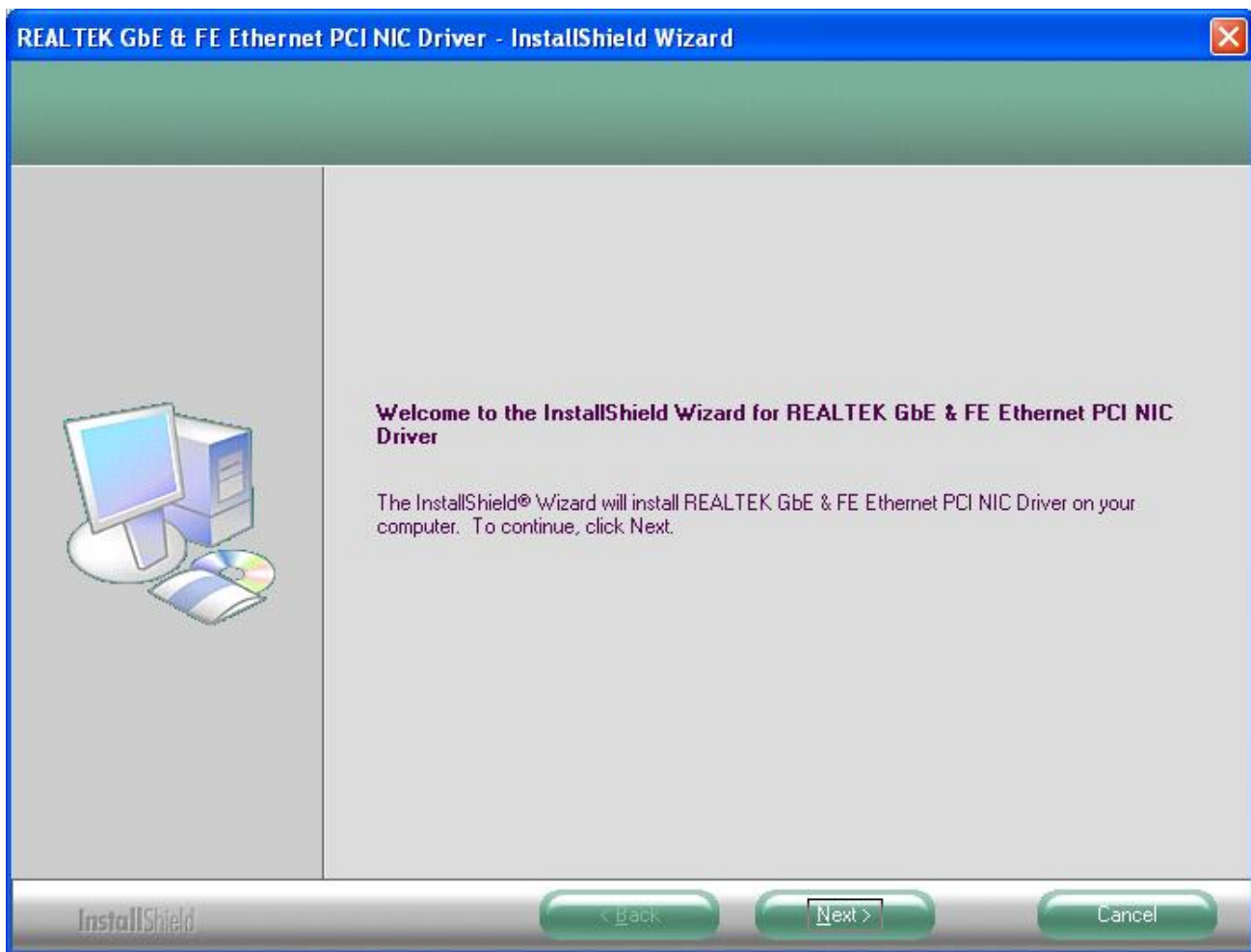

**When the setup window appear then to select the "Next" step.**

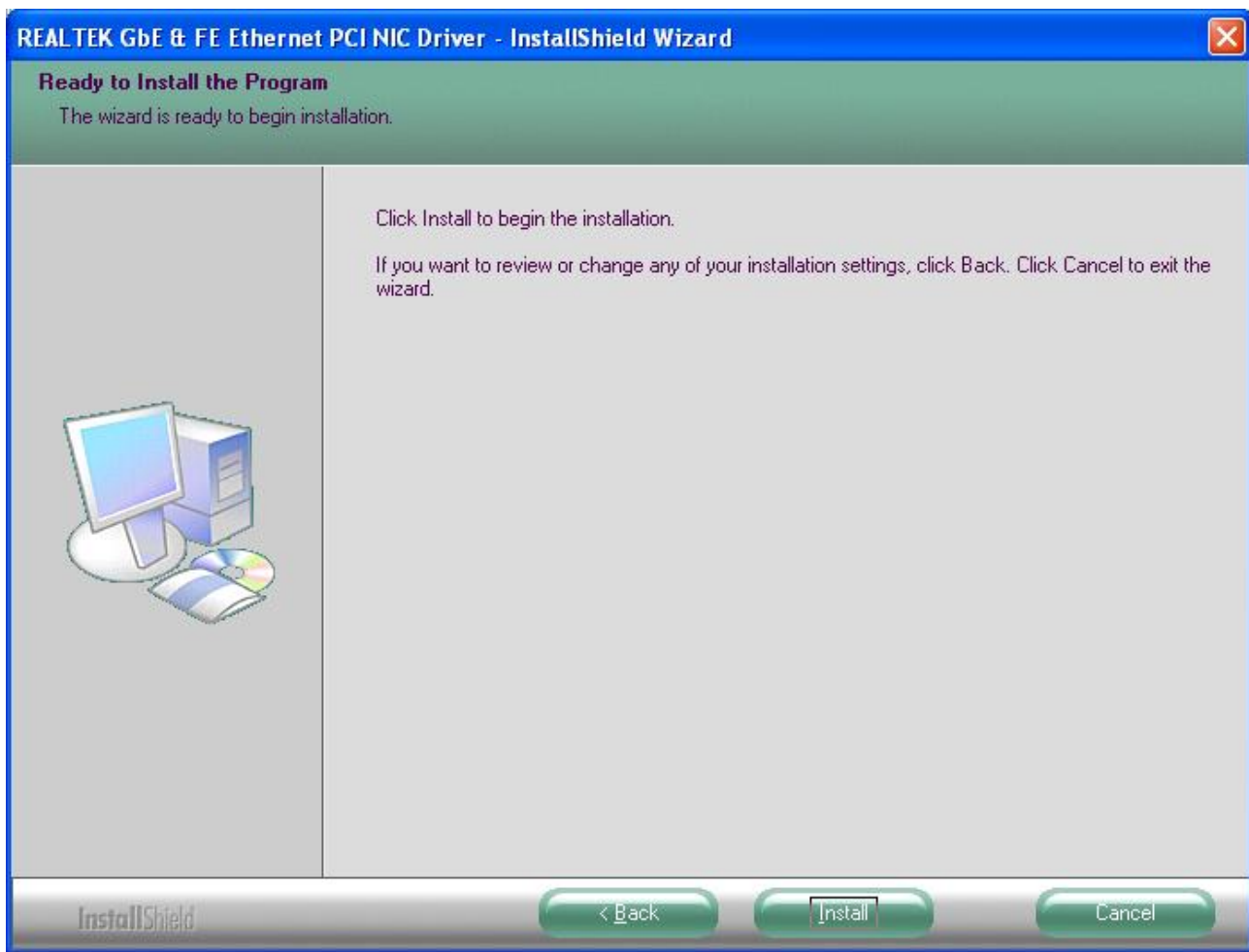

**When the next setup window appears again select the setup to continue the setup process.**

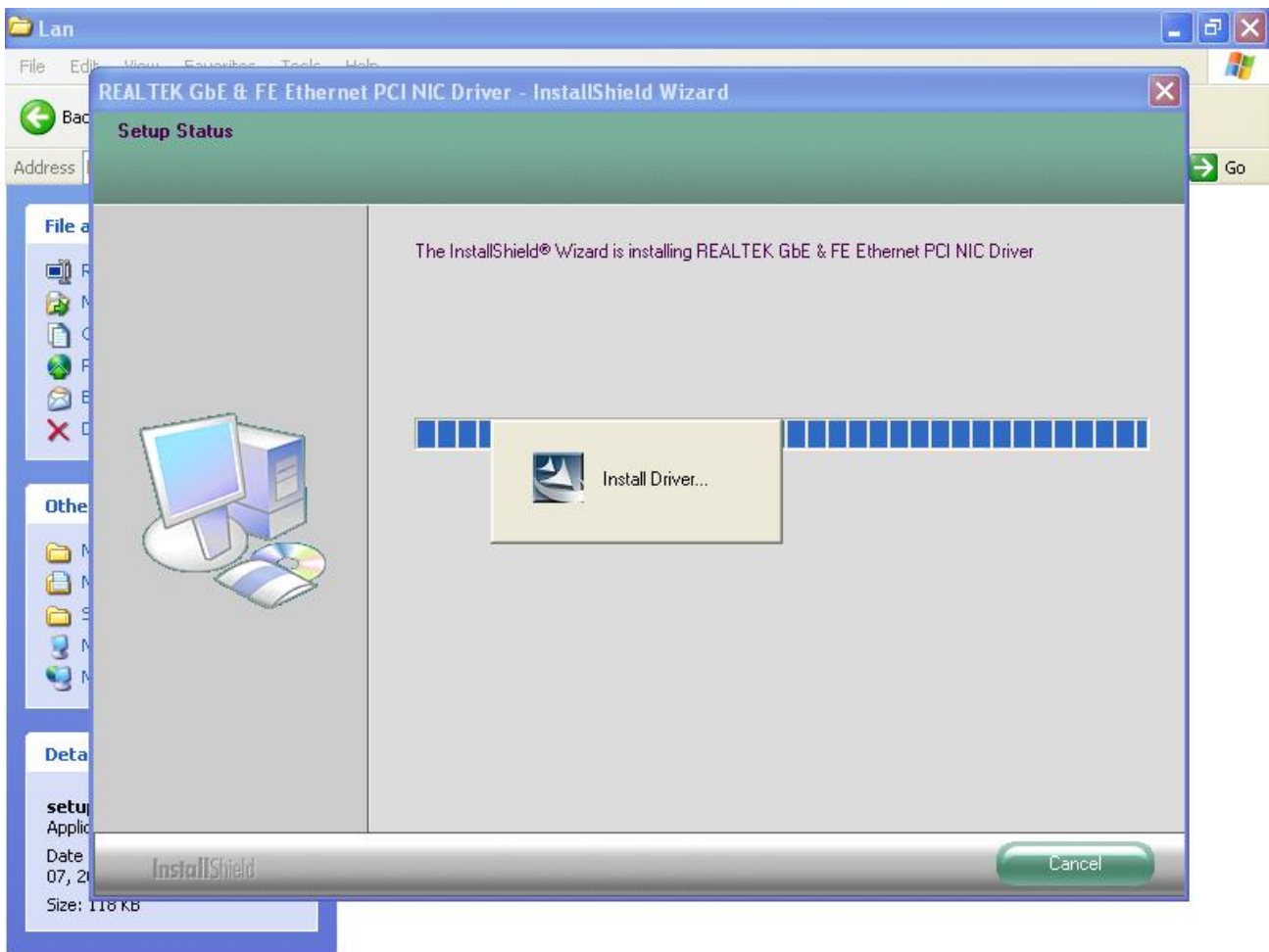

**Above screen shows the installation process window.**

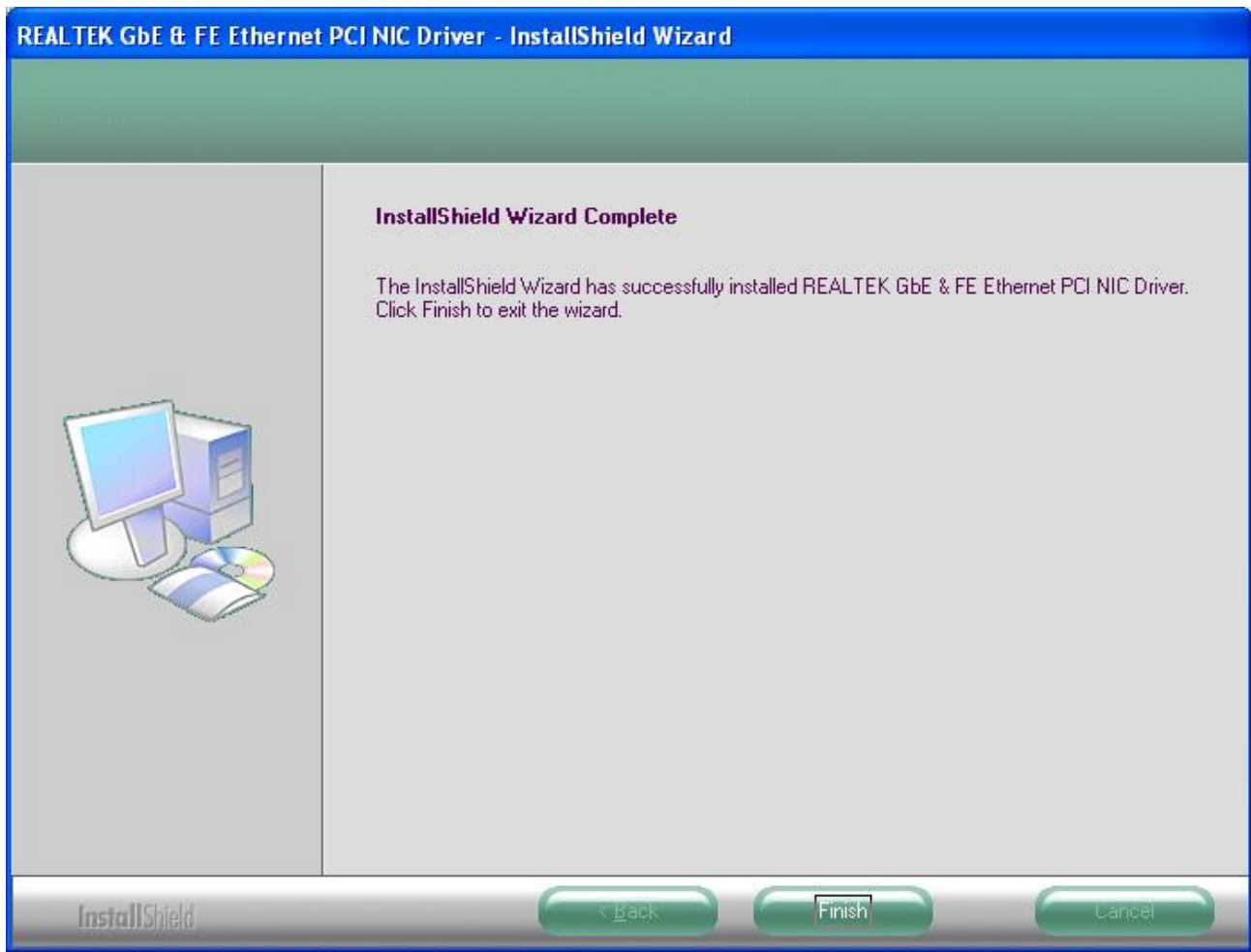

**After installation complete select “Finish”.**

## VGA Drivers



**Insert CD Rom and select "Driver & Manual" file folder.**

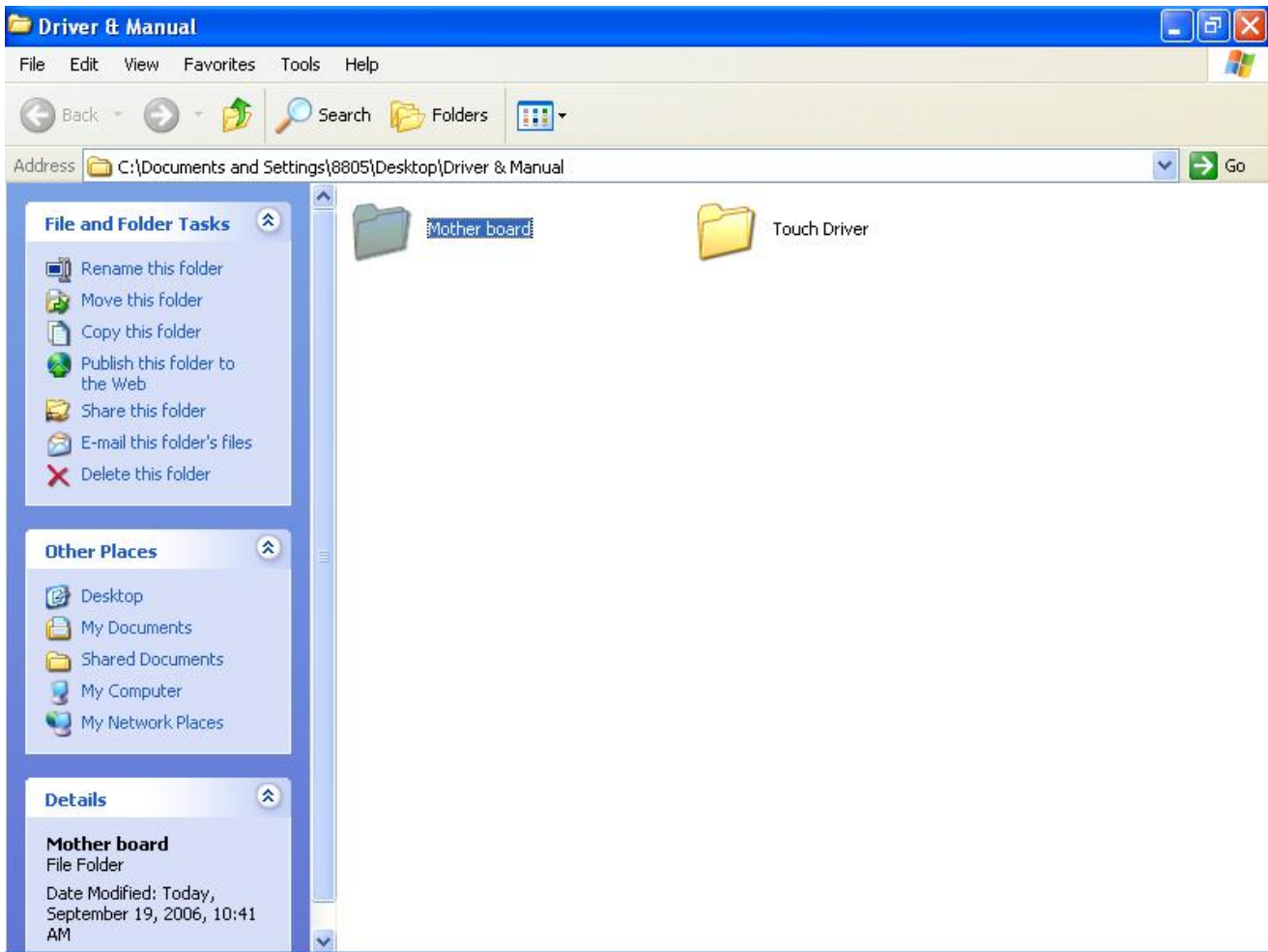

Select "Mother board" folder.

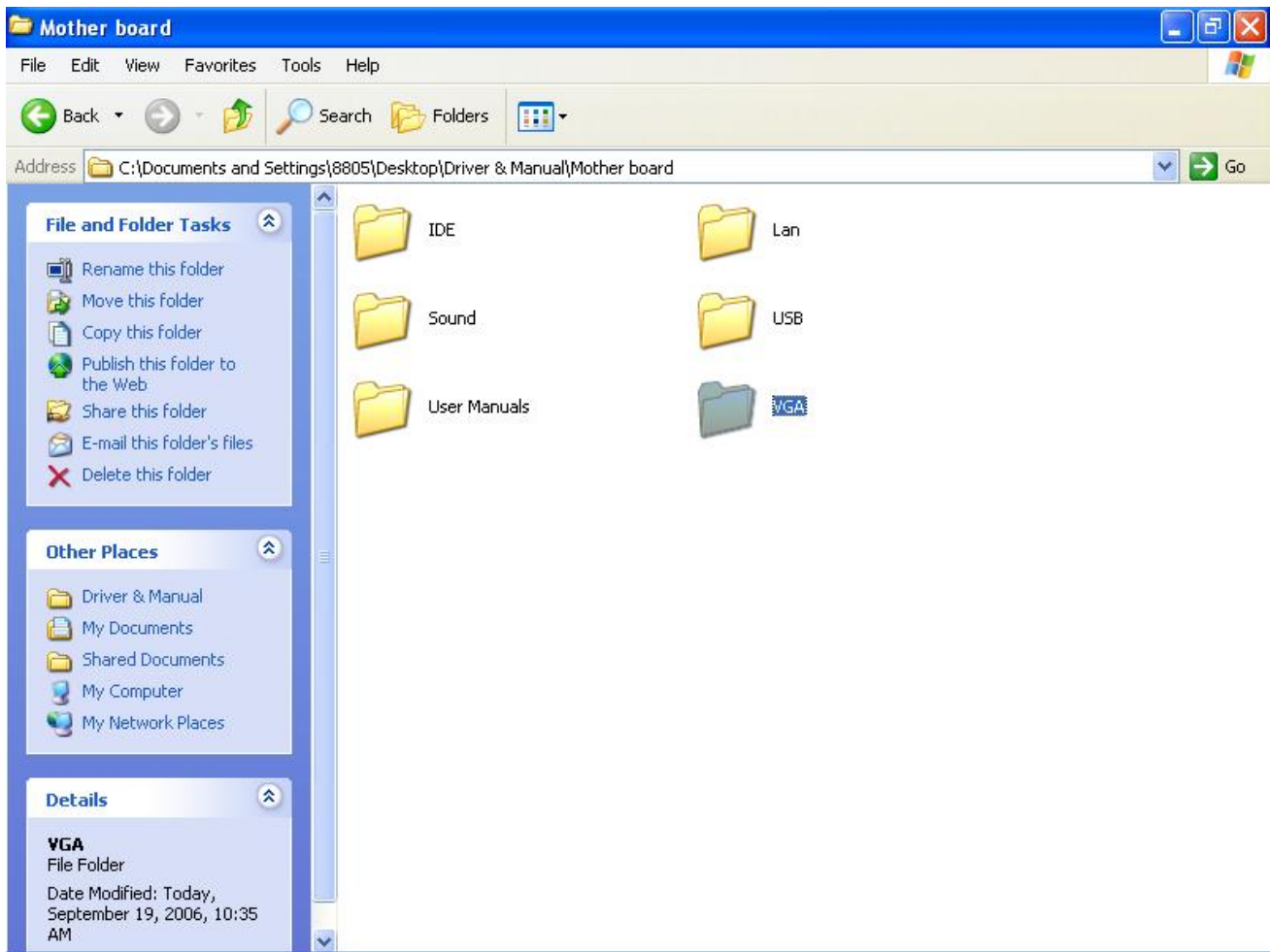

Select "VGA" folder.

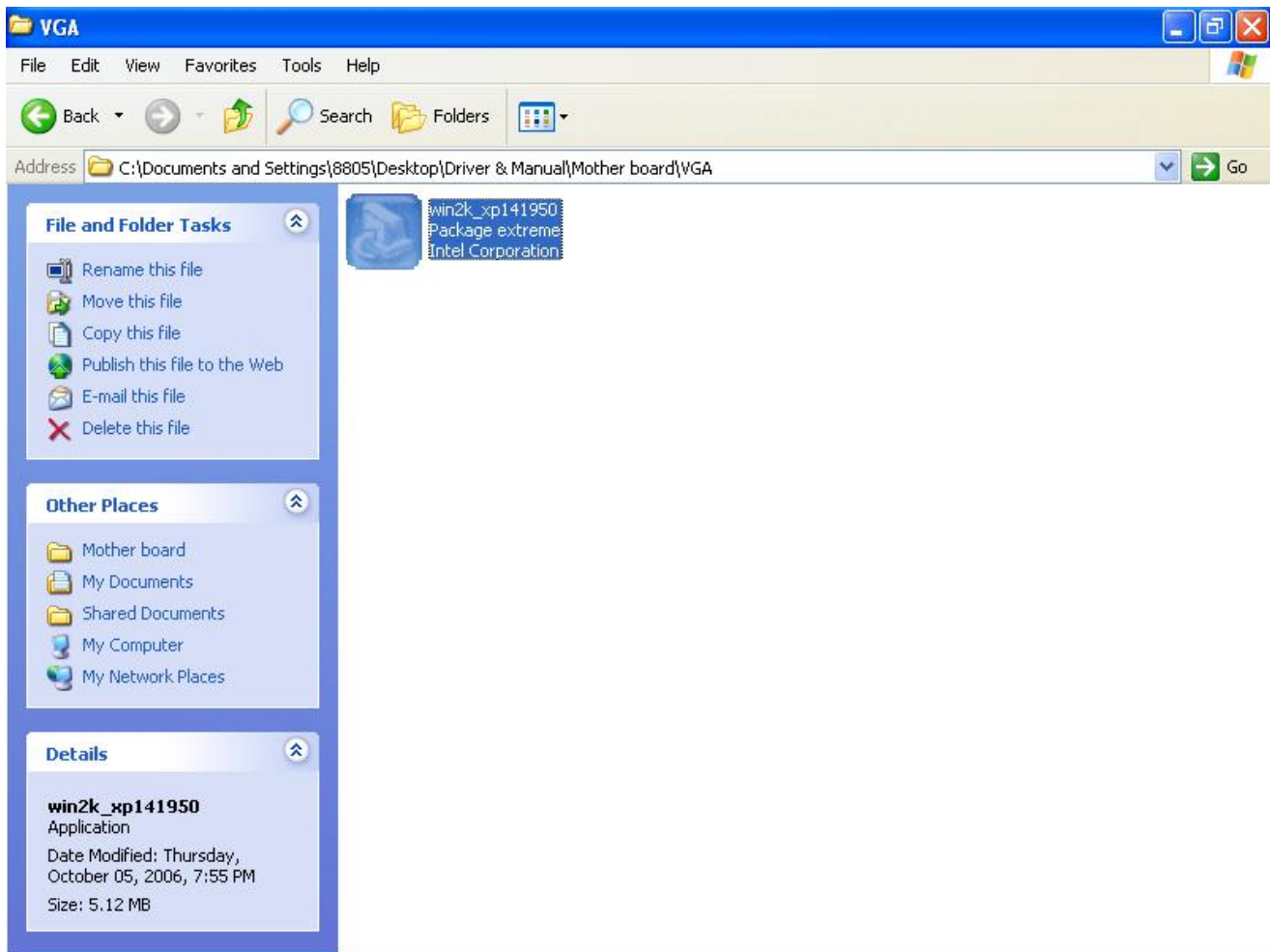

Access "win2k\_xp141950.exe".



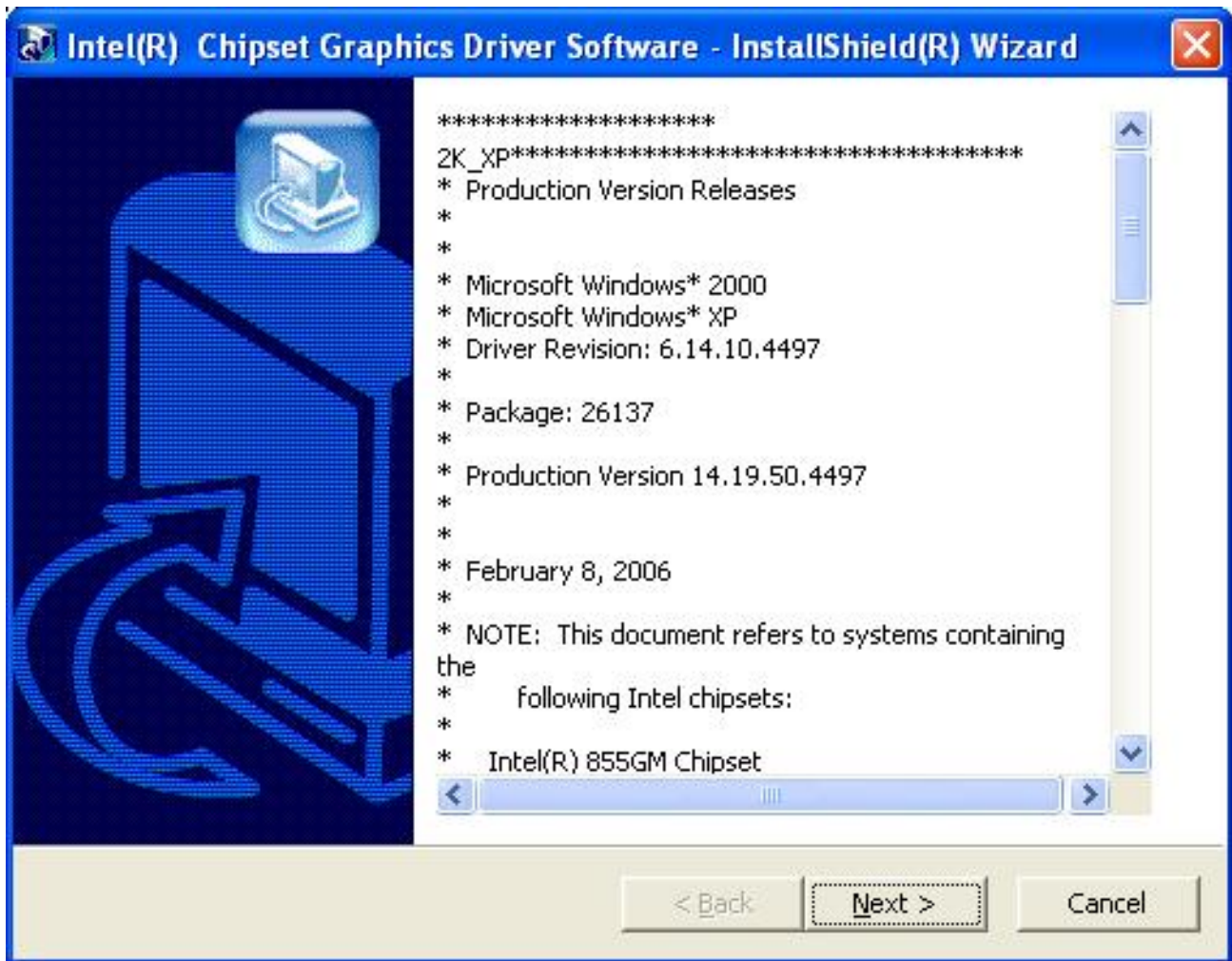

When setup window appear select the "Next" step.

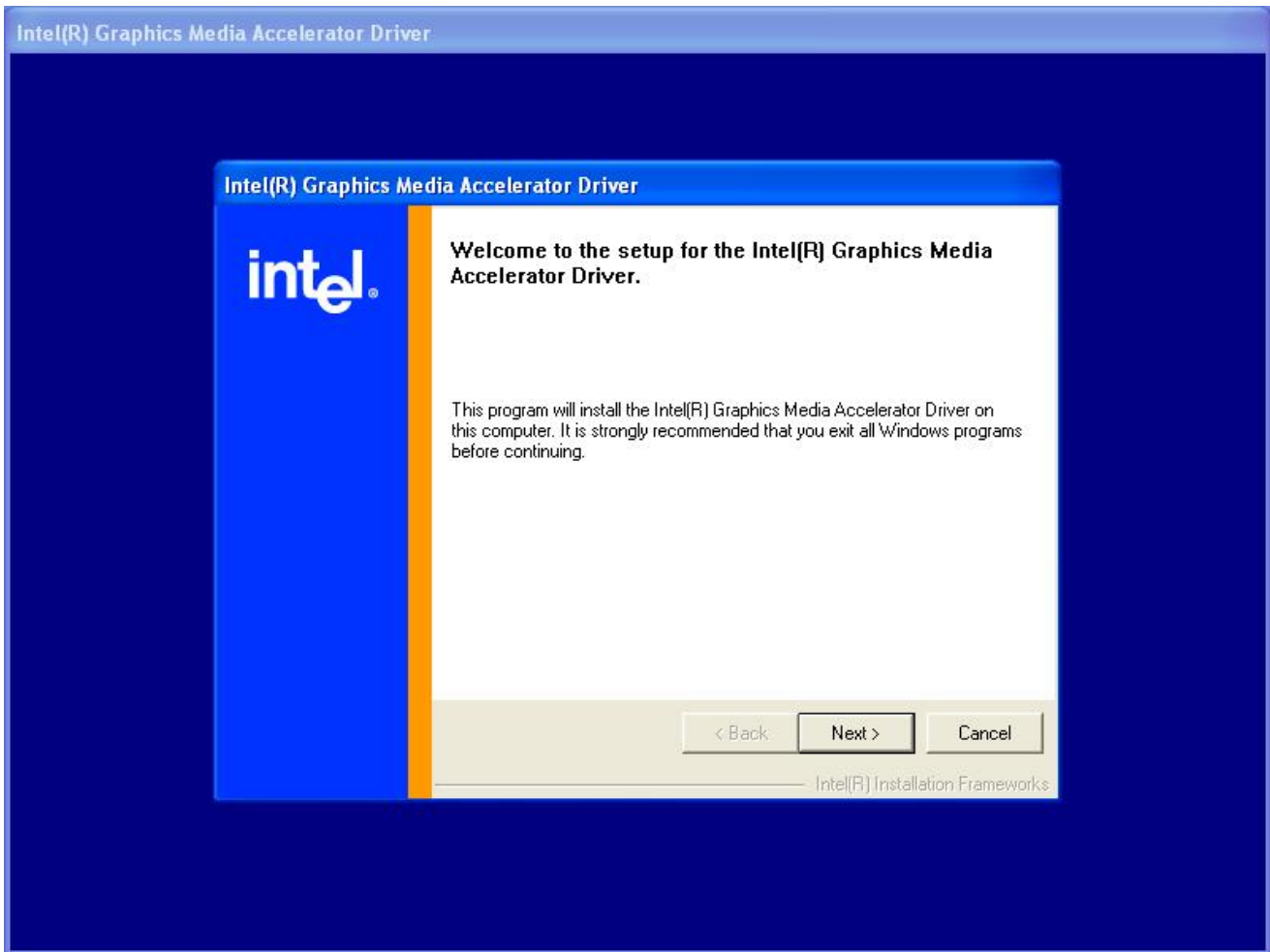

**When next setup window appear select the "Next" step to continue setup.**

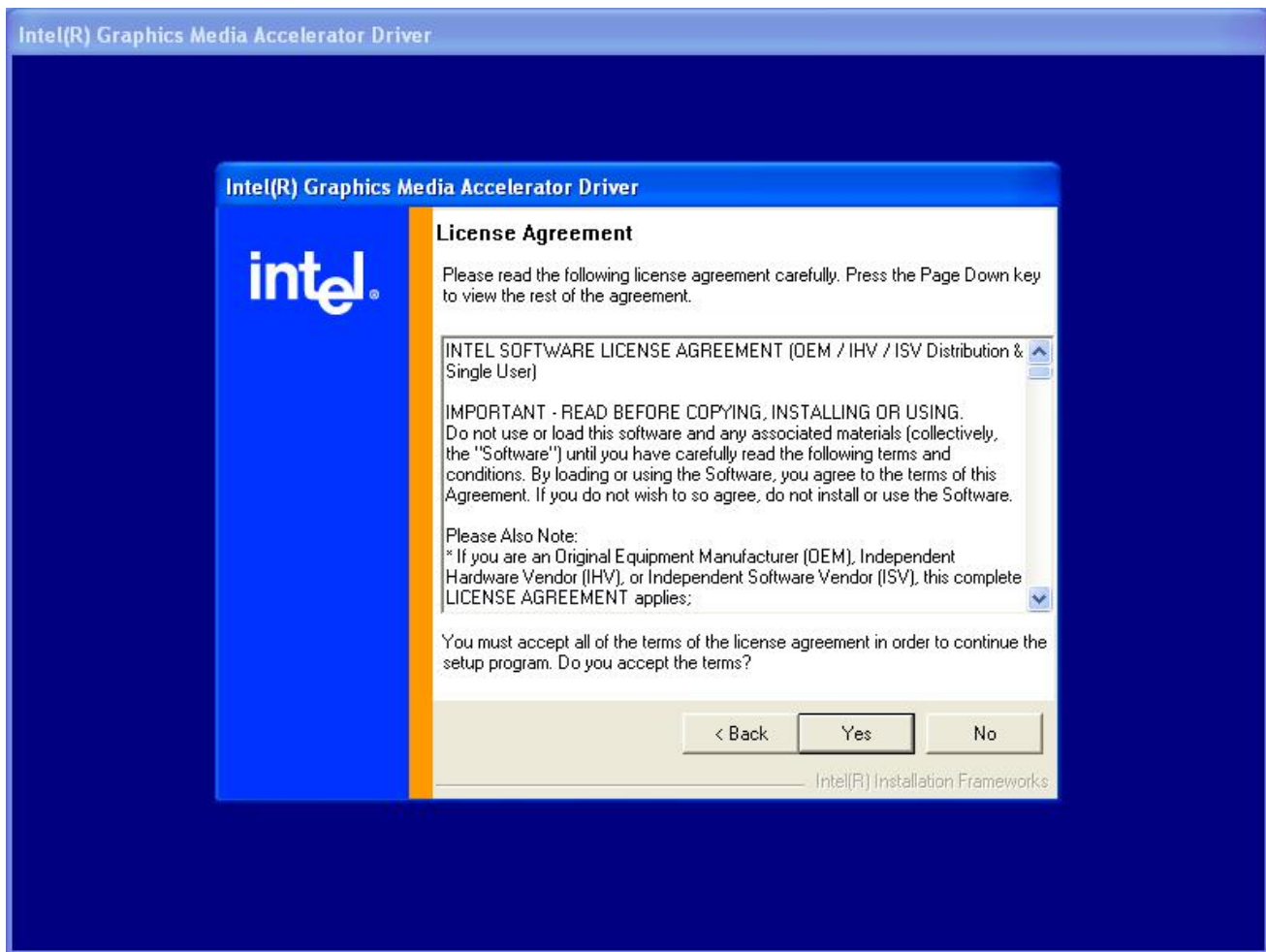

**When setup window appear select the "Next" step.**

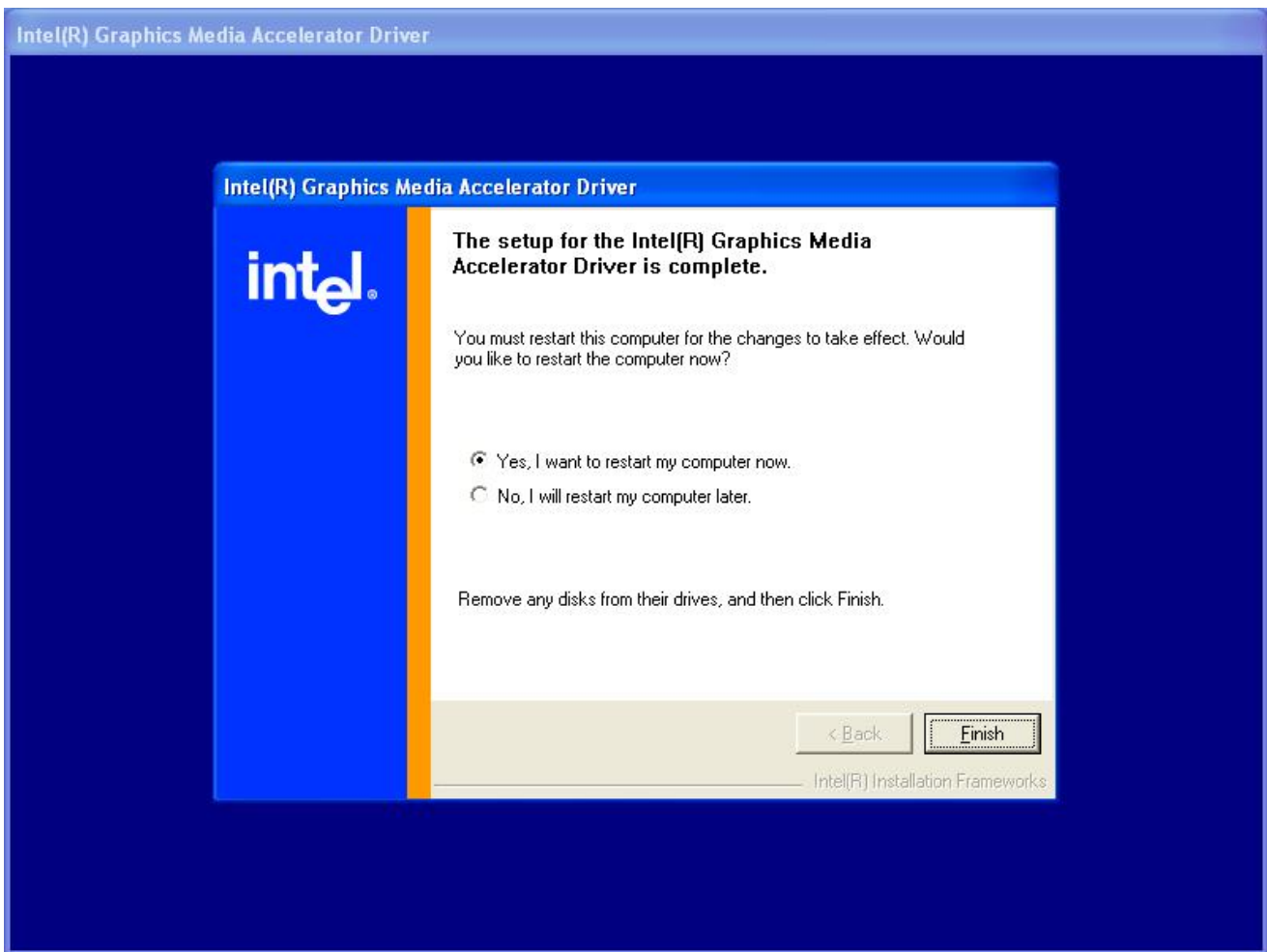

**After installation**

**System will require reboot**

**select “YES”**

## Smart Card Reader Driver



**Right click "My Computer" and select the "Properties".**

"



Select "Device Manager".

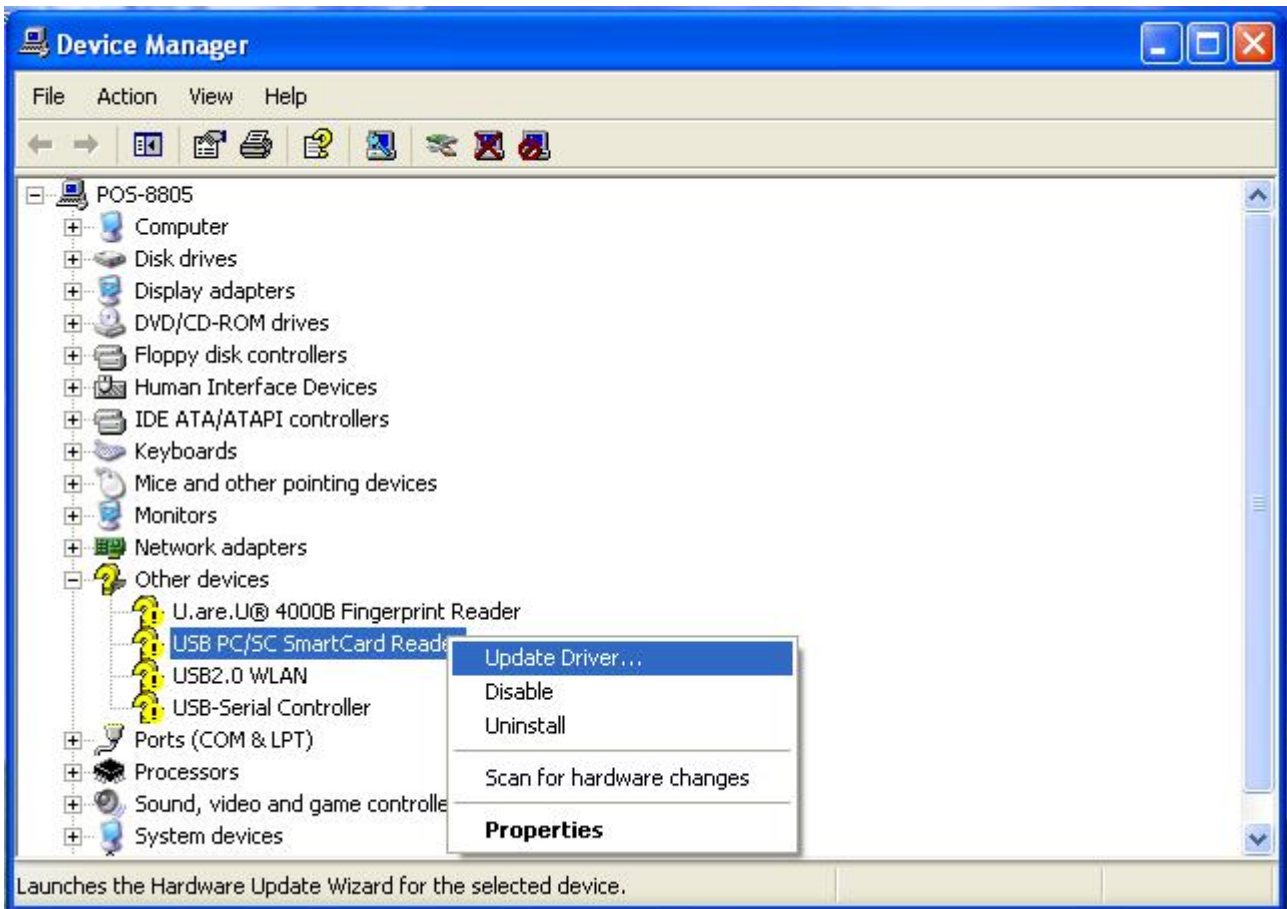

**Select "USB PC/SC Smart Card Reader" and right click to choose "Update Driver".**

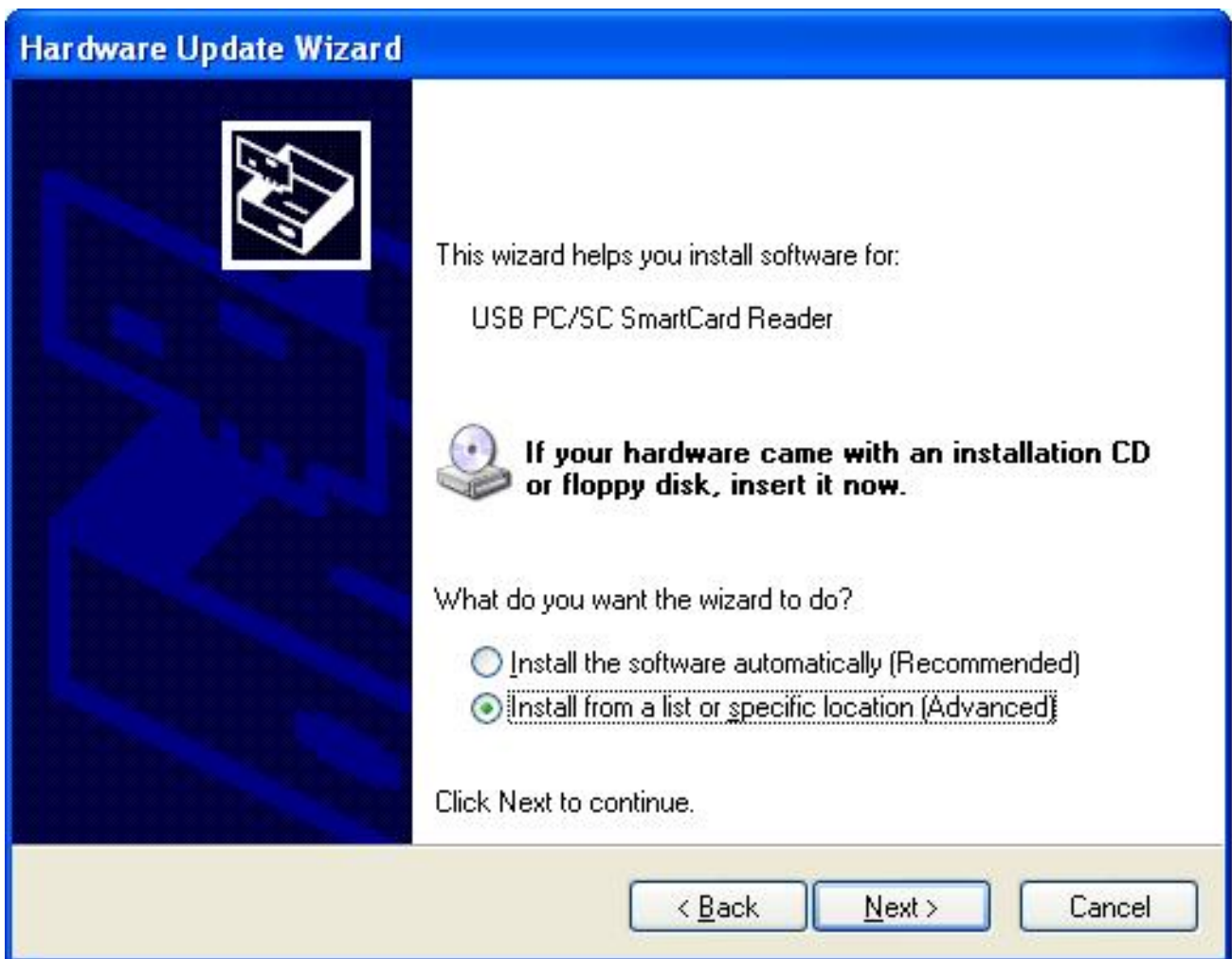

**When the setup screen appears then to select "Advanced" & "Next" step.**





Select "Smartcard USB Driver" folder.

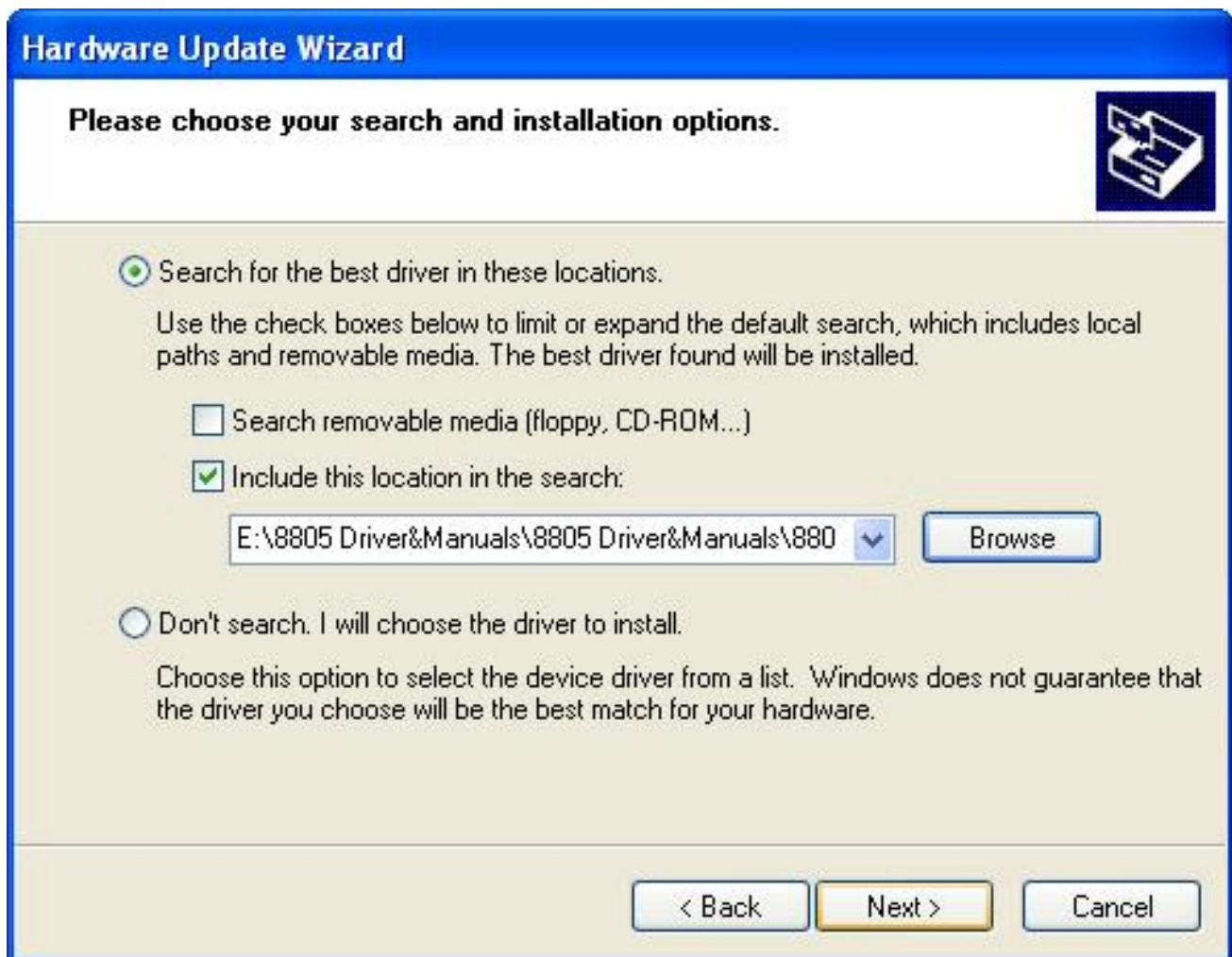

**When next setup window appear select the "Next" step to continue setup.**



When next setup window appear select the "Continue Anyway" step to continue setup.

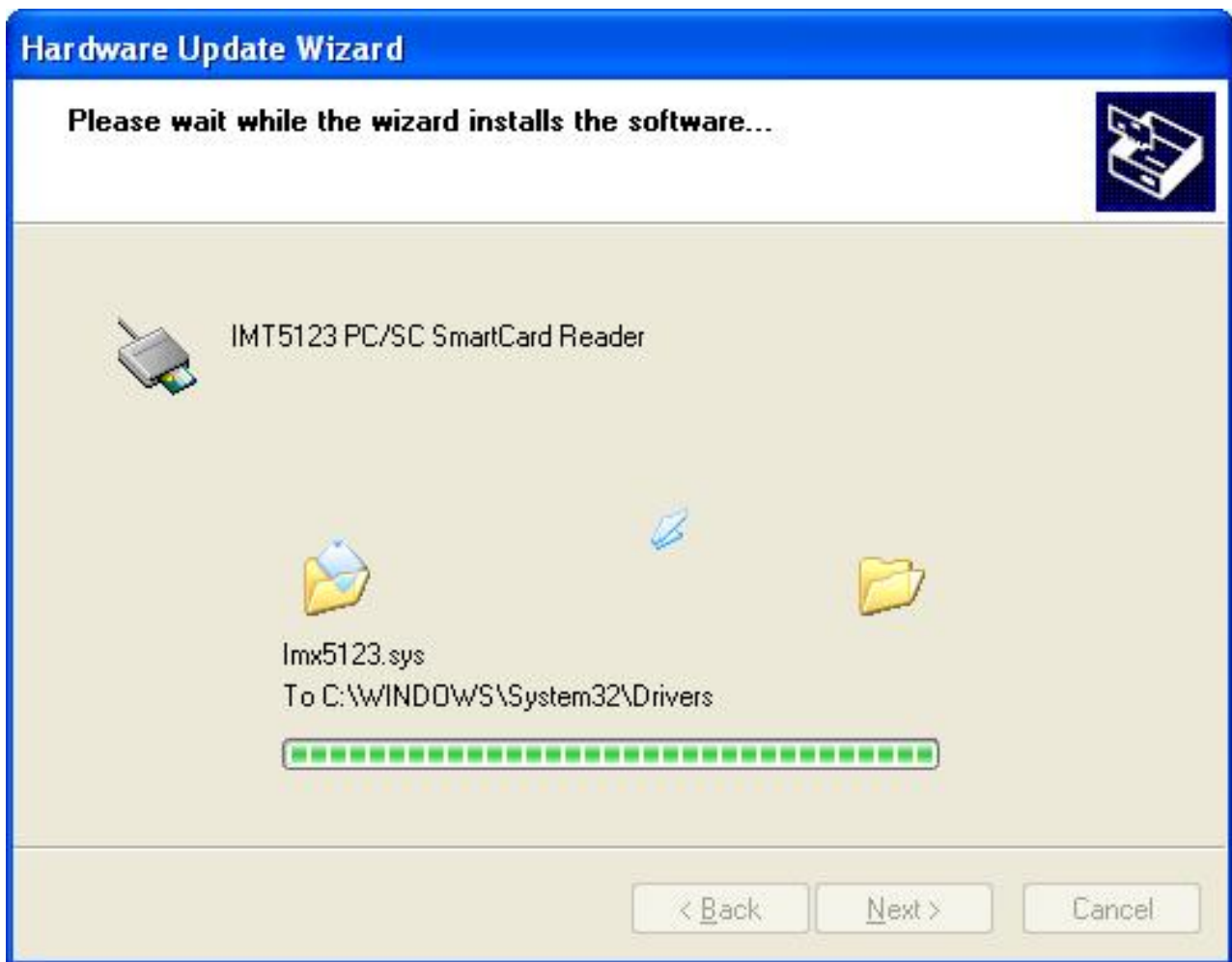

**Above screen shows the installation process window.**



**After installation complete select “Finish”.**

## Wi-Fi Driver



**Right click "My Computer" and select the "Properties".**



Select "Device Manager".

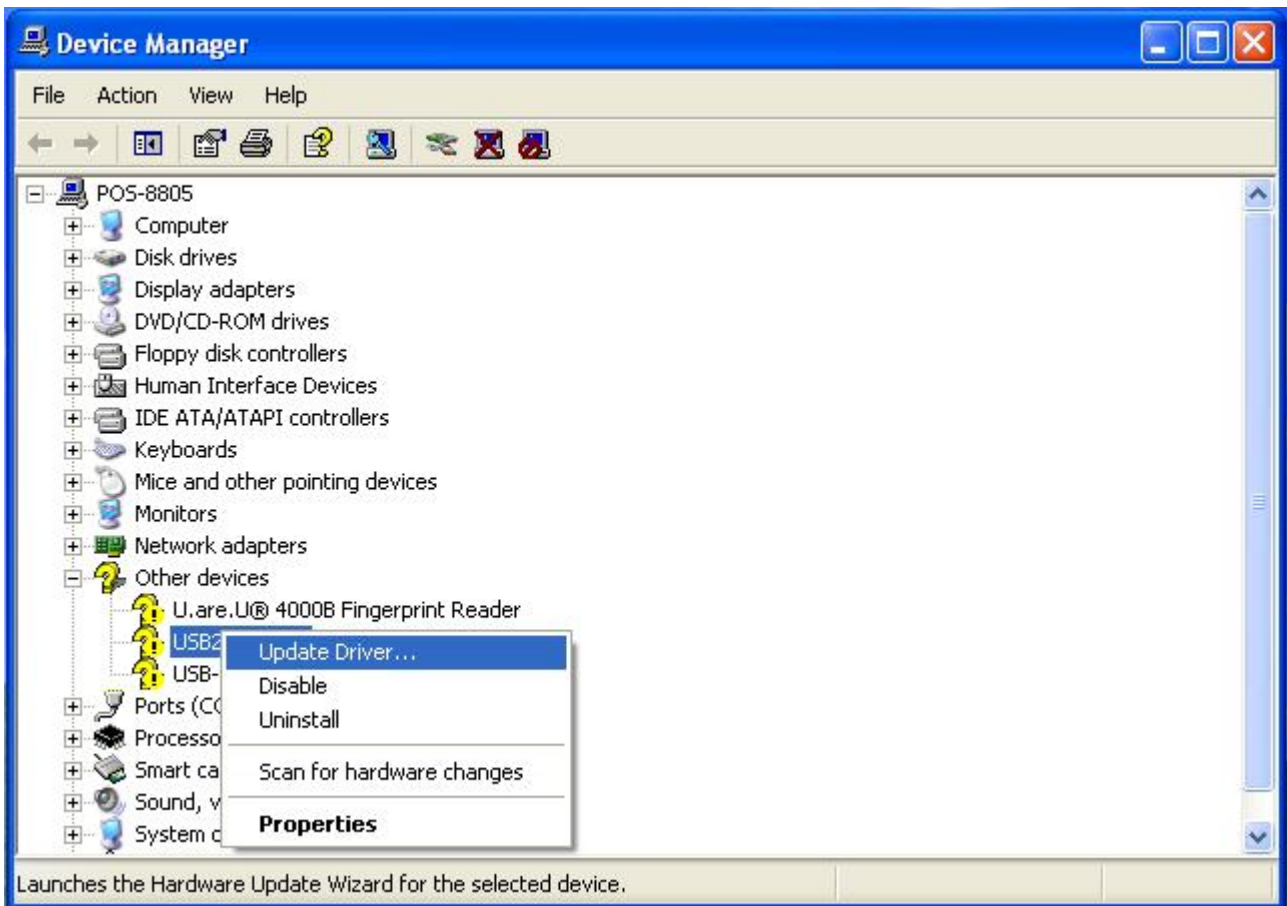

Select "USB2.0 WLAN" and right click to choose "Update Driver".



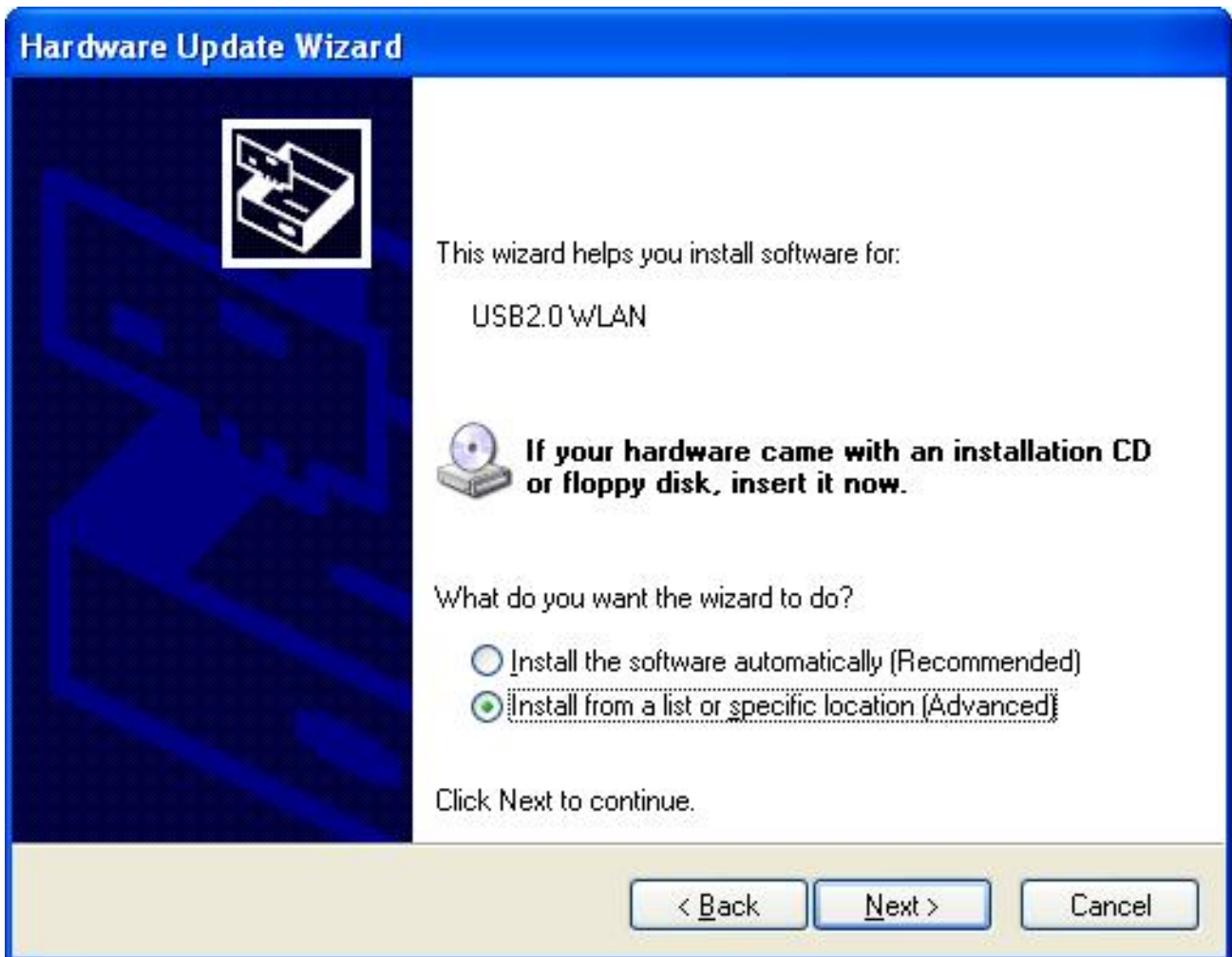

When the setup screen appears then to select "Advanced" & "Next" step.



**Select Wi-Fi Driver folder.**

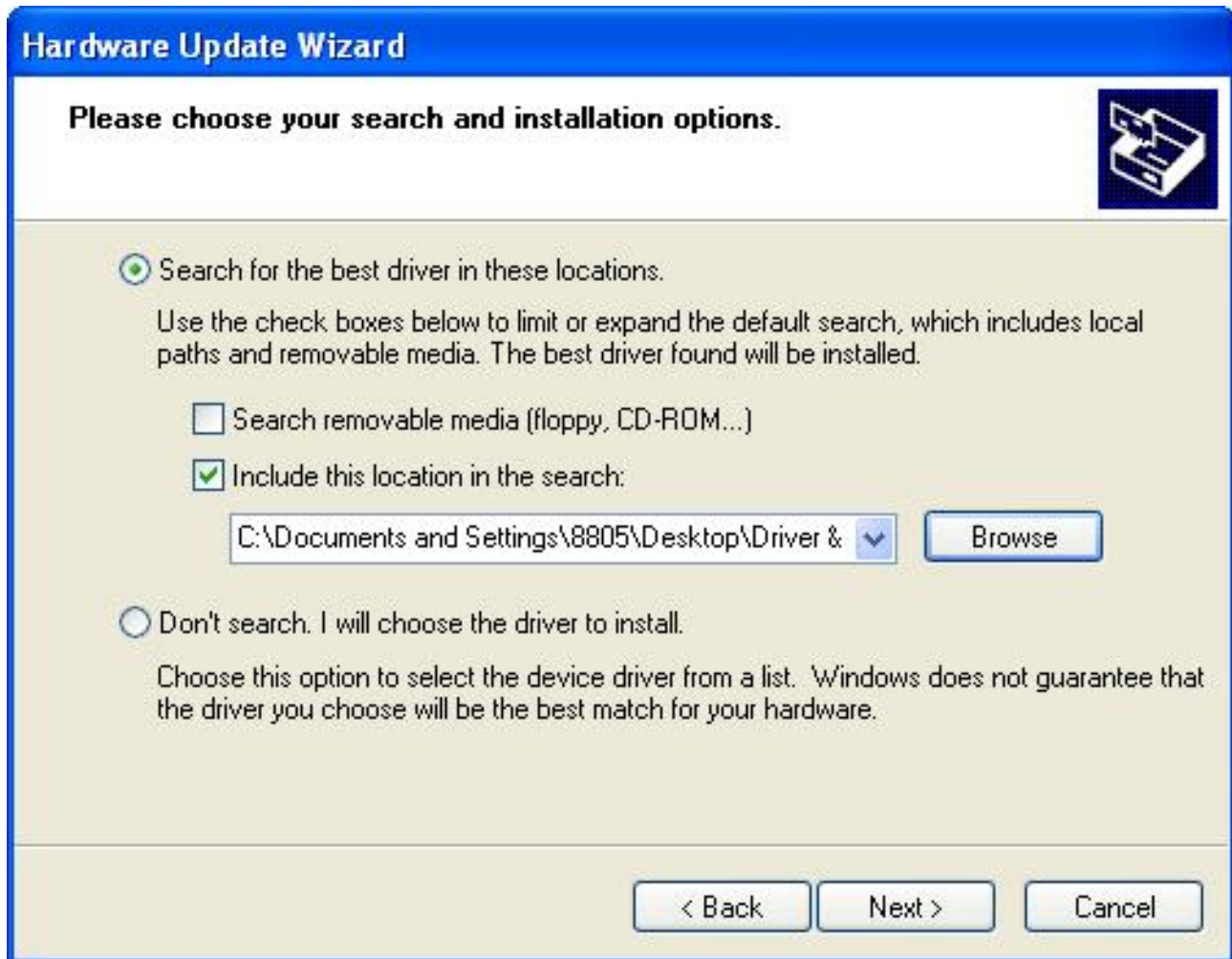

**When next setup window appear select the "Next" step to continue setup.**

## Hardware Installation



The software you are installing for this hardware:

802.11b+g USB Wireless LAN Adapter

has not passed Windows Logo testing to verify its compatibility with Windows XP. [\(Tell me why this testing is important.\)](#)

**Continuing your installation of this software may impair or destabilize the correct operation of your system either immediately or in the future. Microsoft strongly recommends that you stop this installation now and contact the hardware vendor for software that has passed Windows Logo testing.**

Continue Anyway

STOP Installation

When next setup window appear select the "Continue Anyway" step to continue setup.

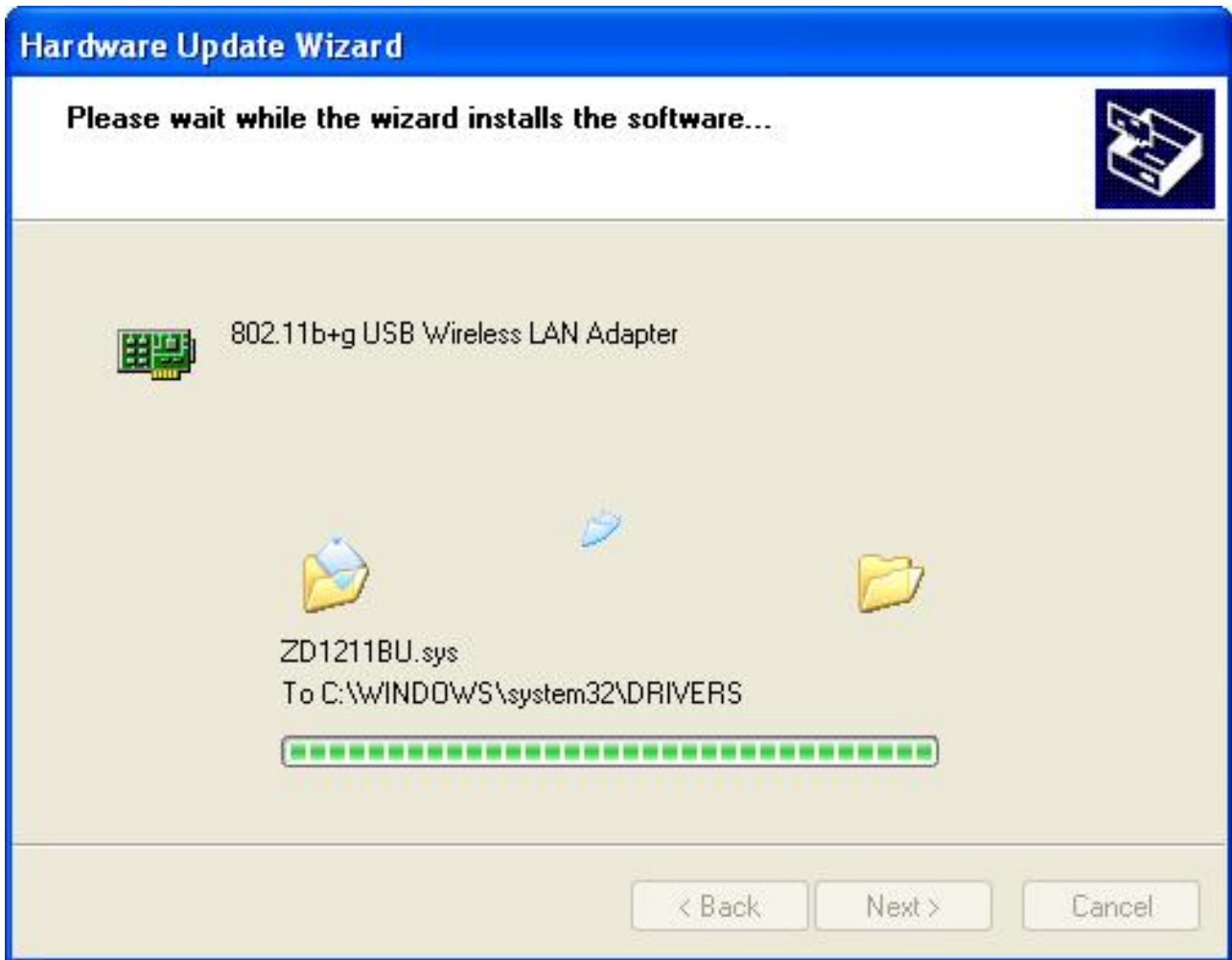

Above screen shows the installation process window.



**After installation complete select “Finish”.**

## Mifare Driver

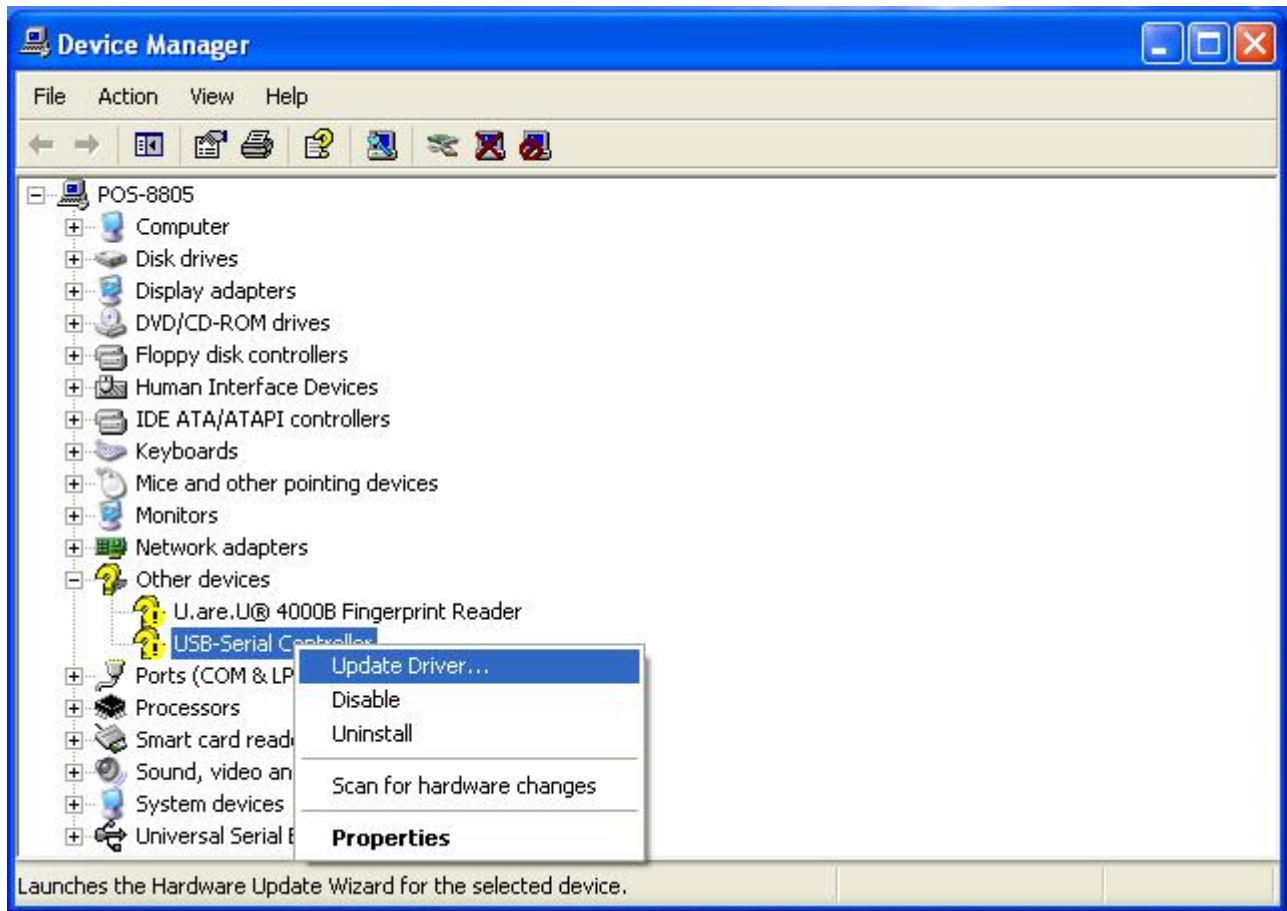

Select "USB-Serial Control" and right click to choose "Update Driver".

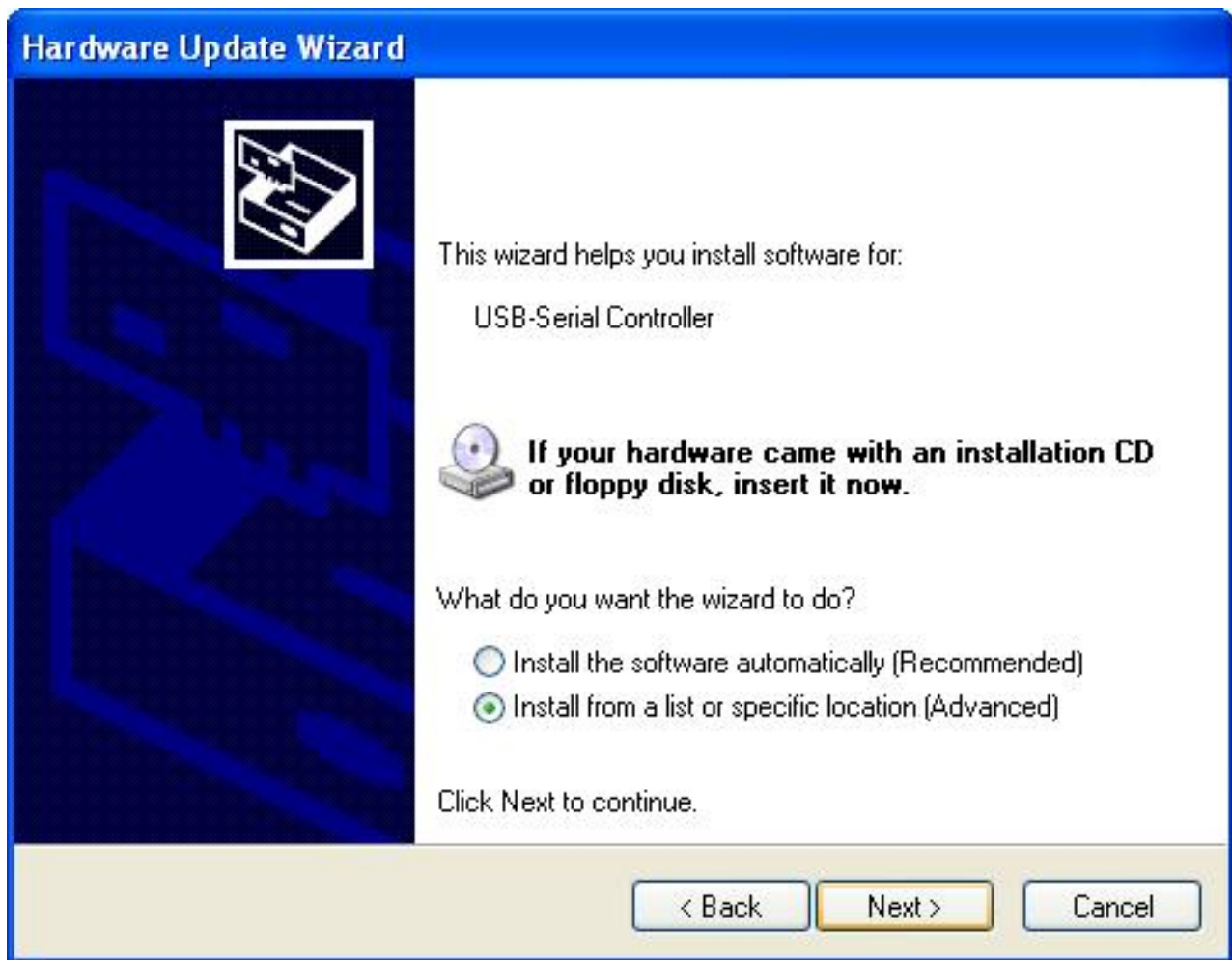

**When the setup screen appears then to select "Advanced" & "Next" step.**





Select "Mifare Driver" folder.

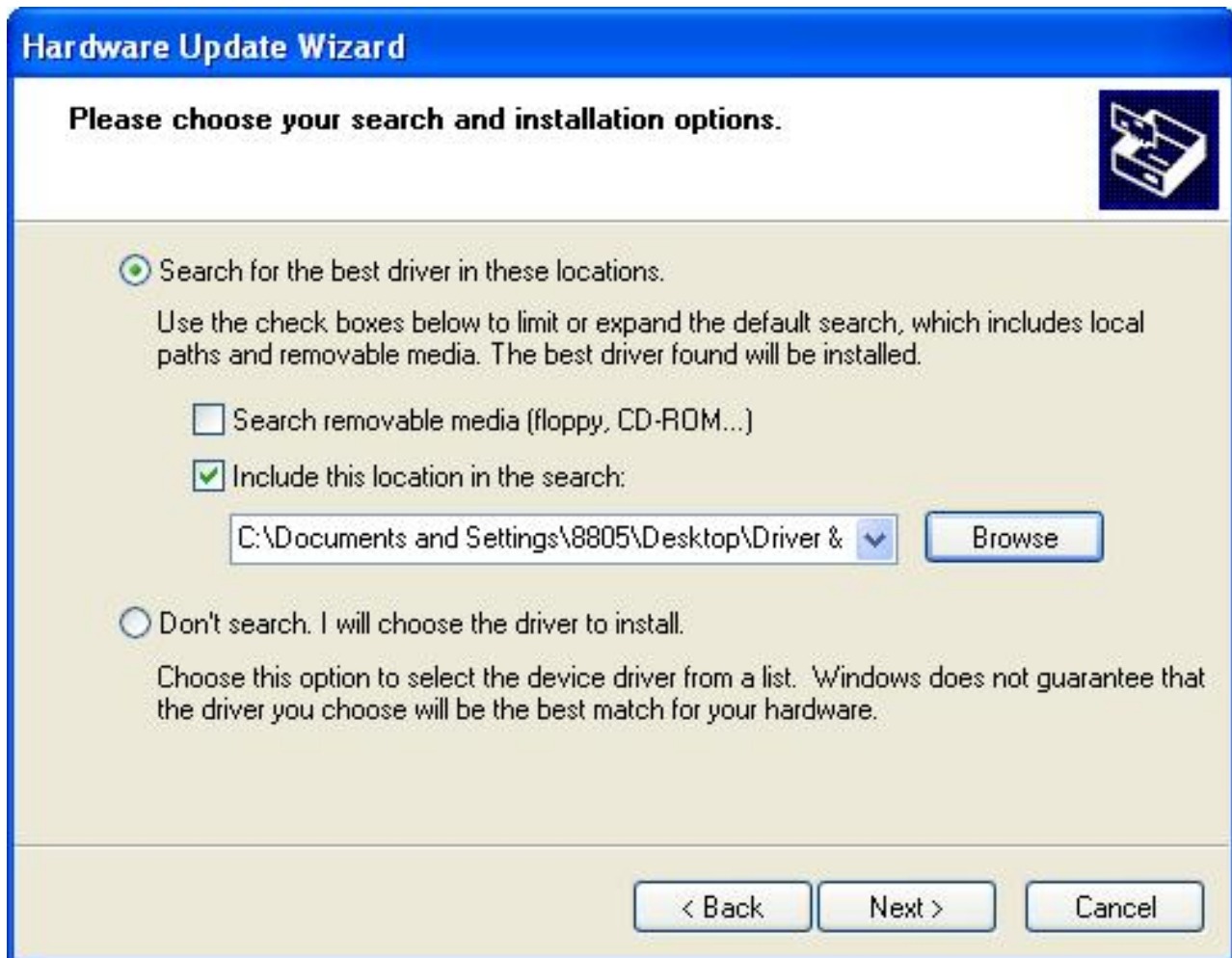

**When next setup window appear select the "Next" step to continue setup.**



When next setup window appear select the "Continue Anyway" step to continue setup.

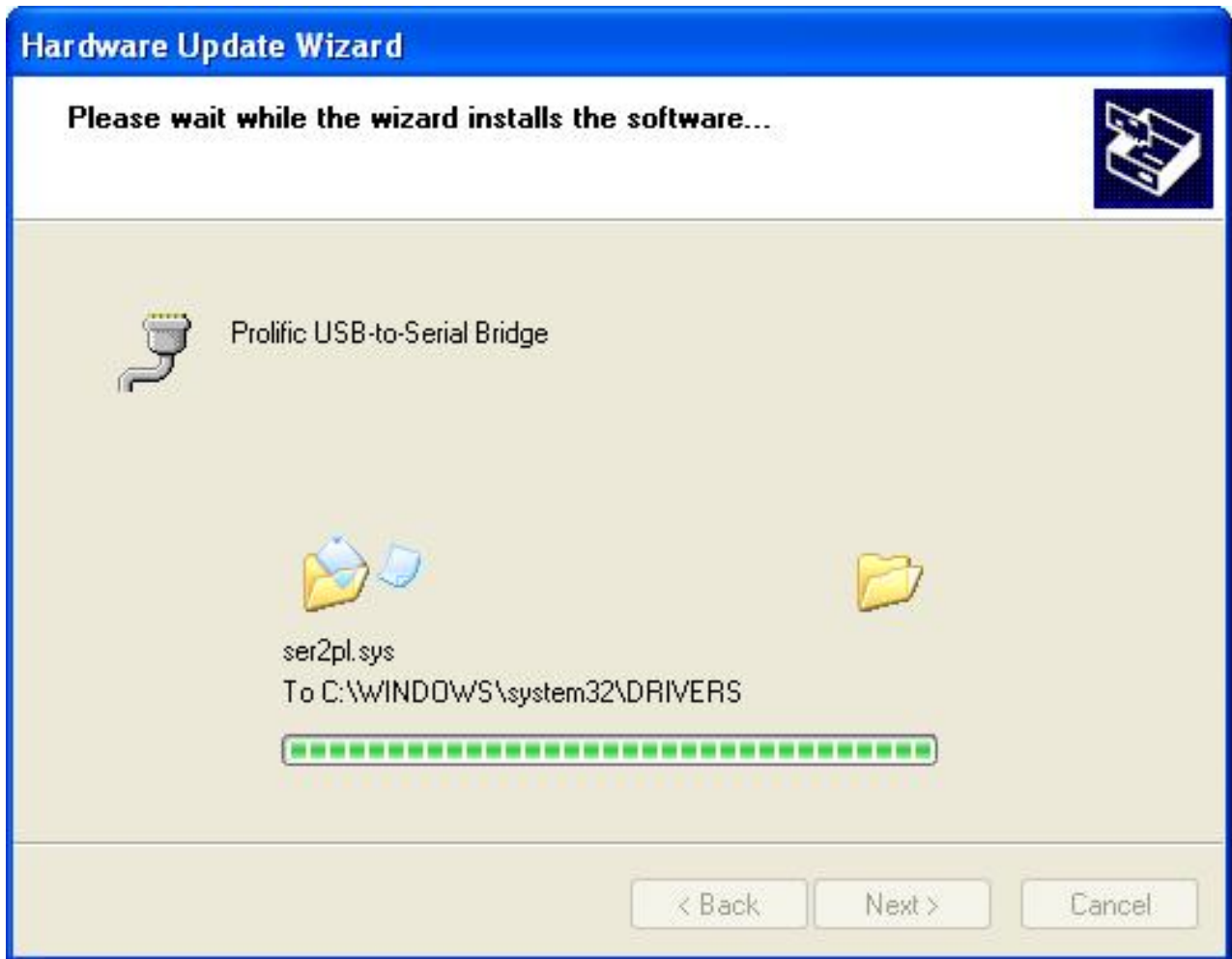

Above screen shows the installation process window.



**After installation complete select “Finish”.**

## Fingerprinter Driver

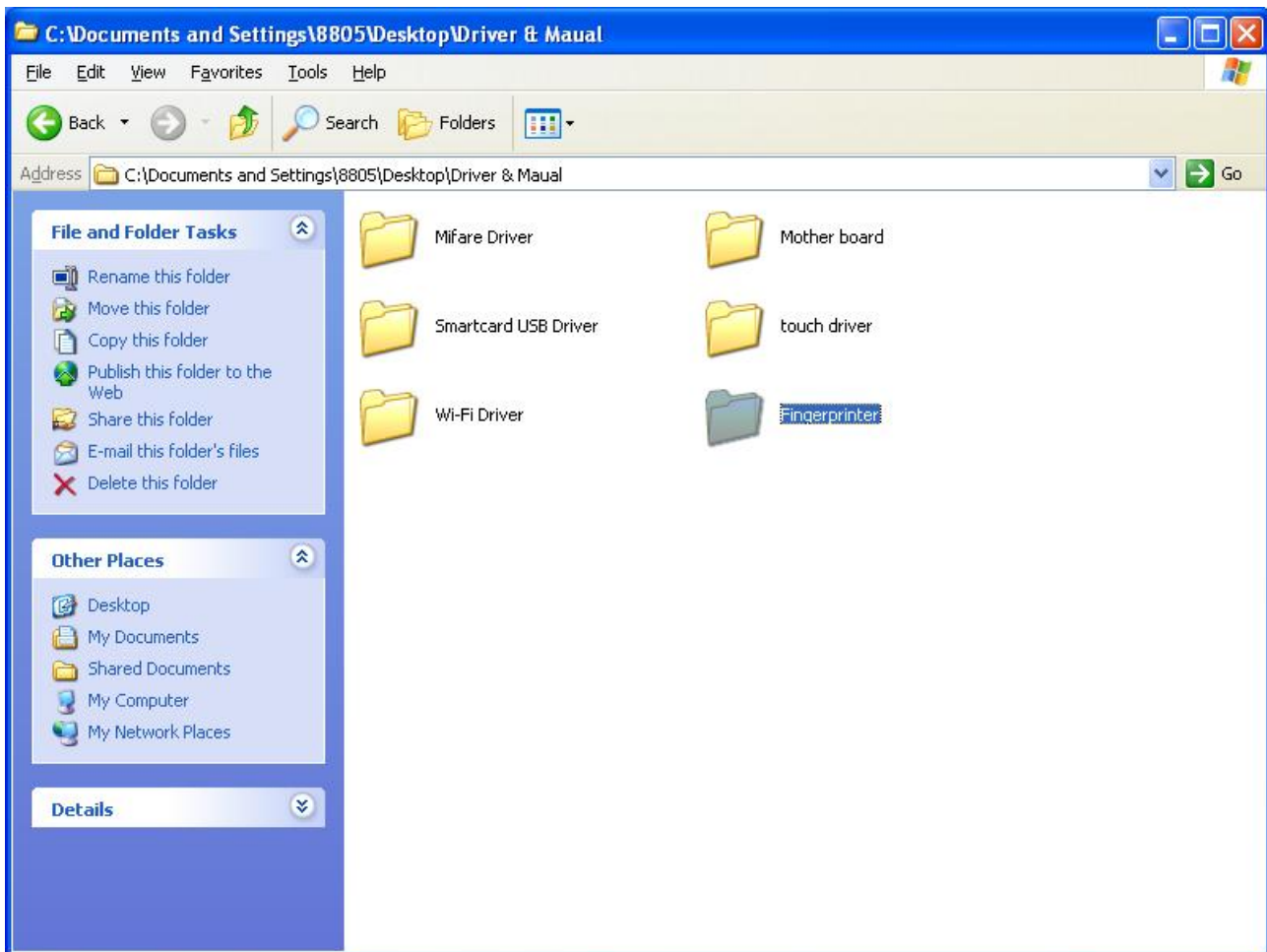

Select "Fingerprinter" folder.

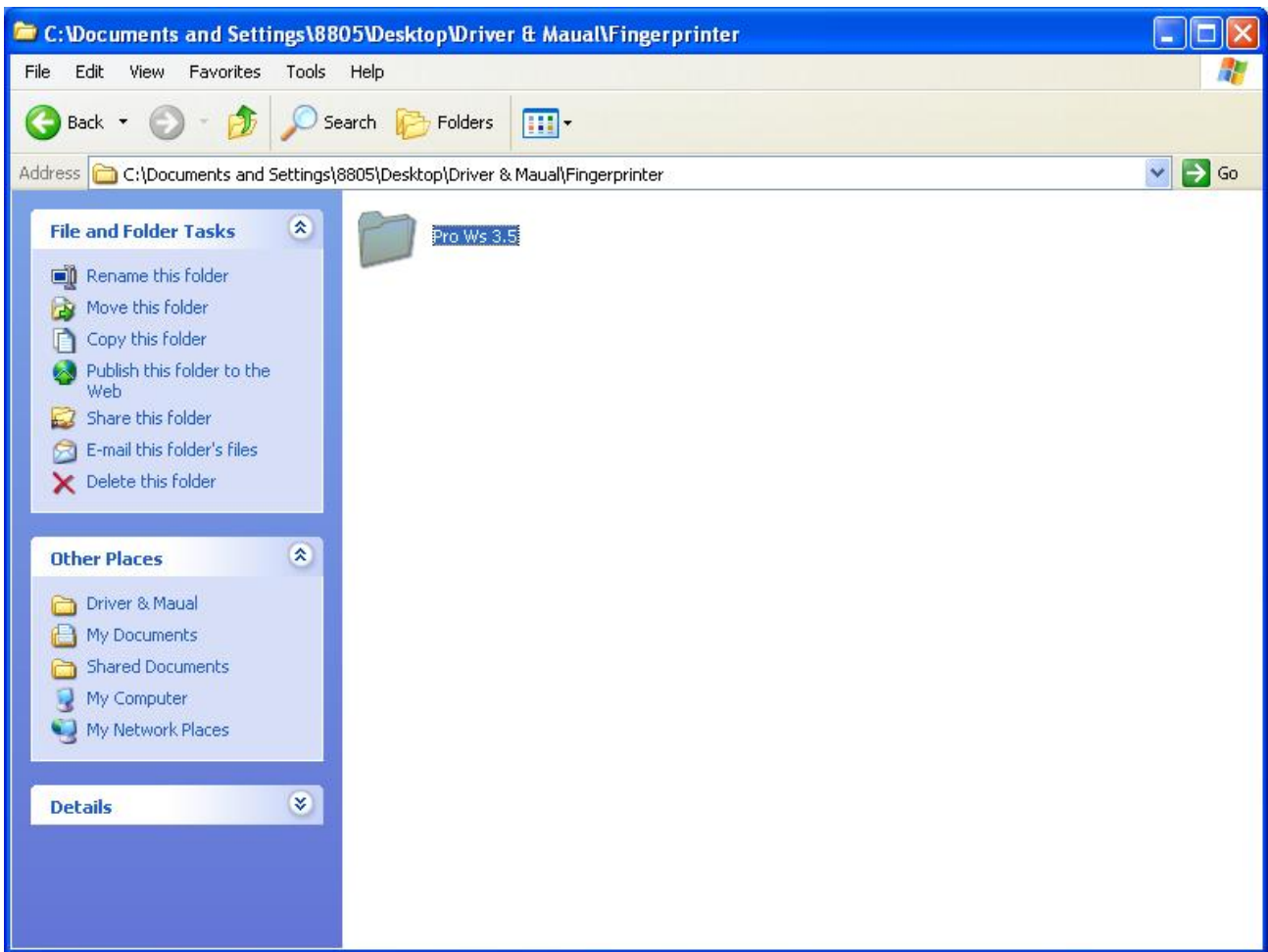

Select "Pro Ws 3.5" folder.

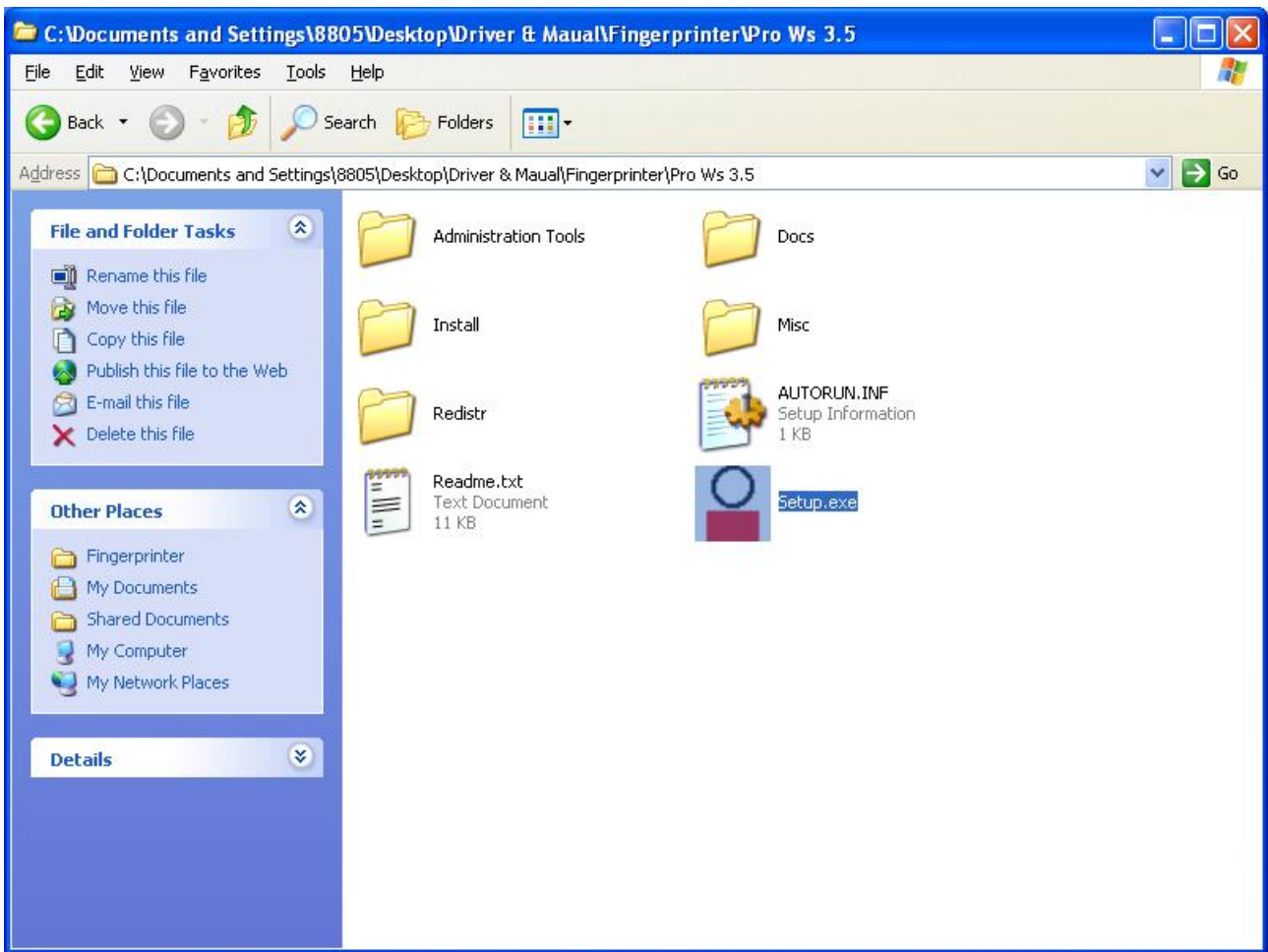

Access the "Setup".





**When the setup window appear then to select the "Next" step.**

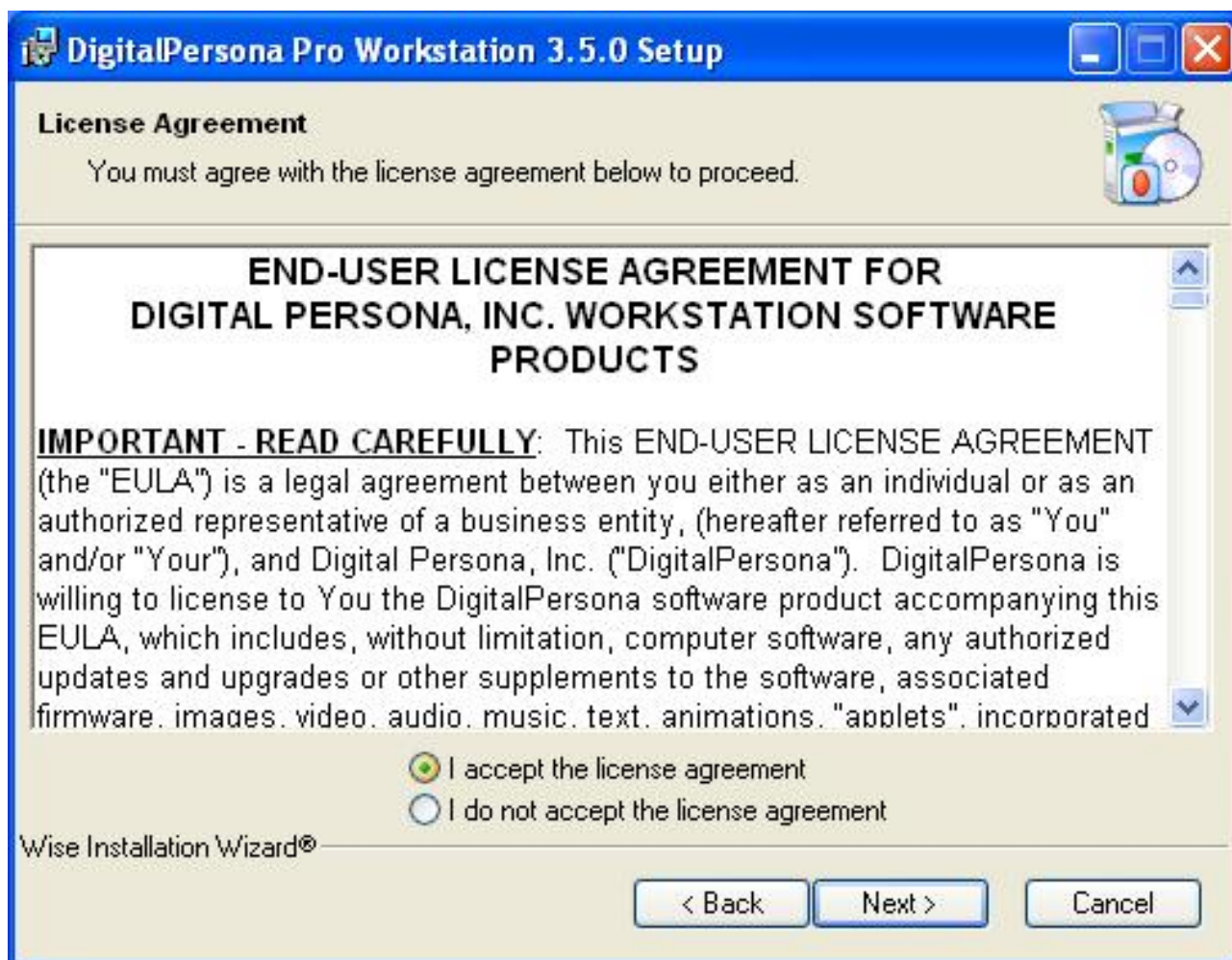

When the setup window appear then to select the "I accept & Next" step.

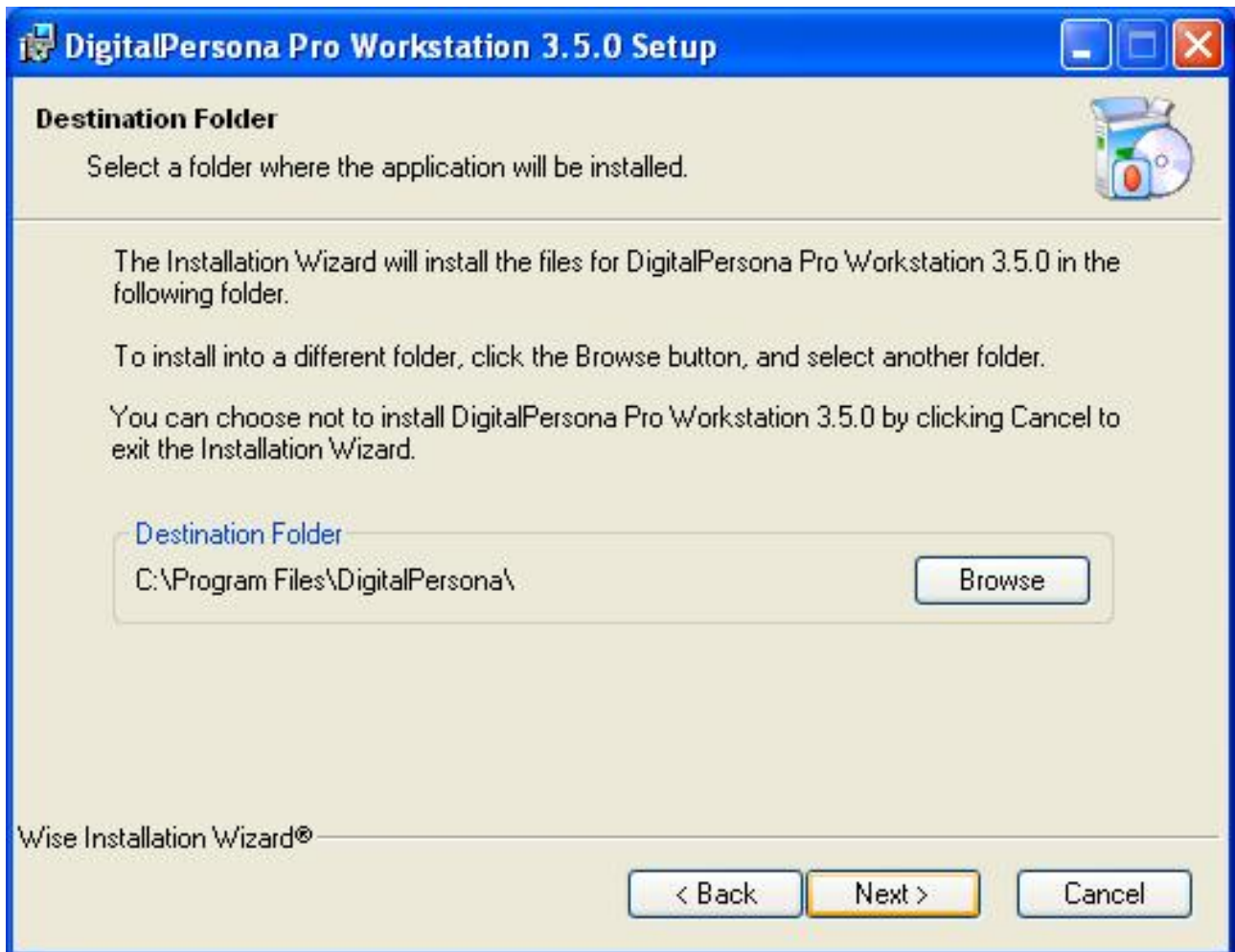

**When the setup window appear then to select the "Next" step.**

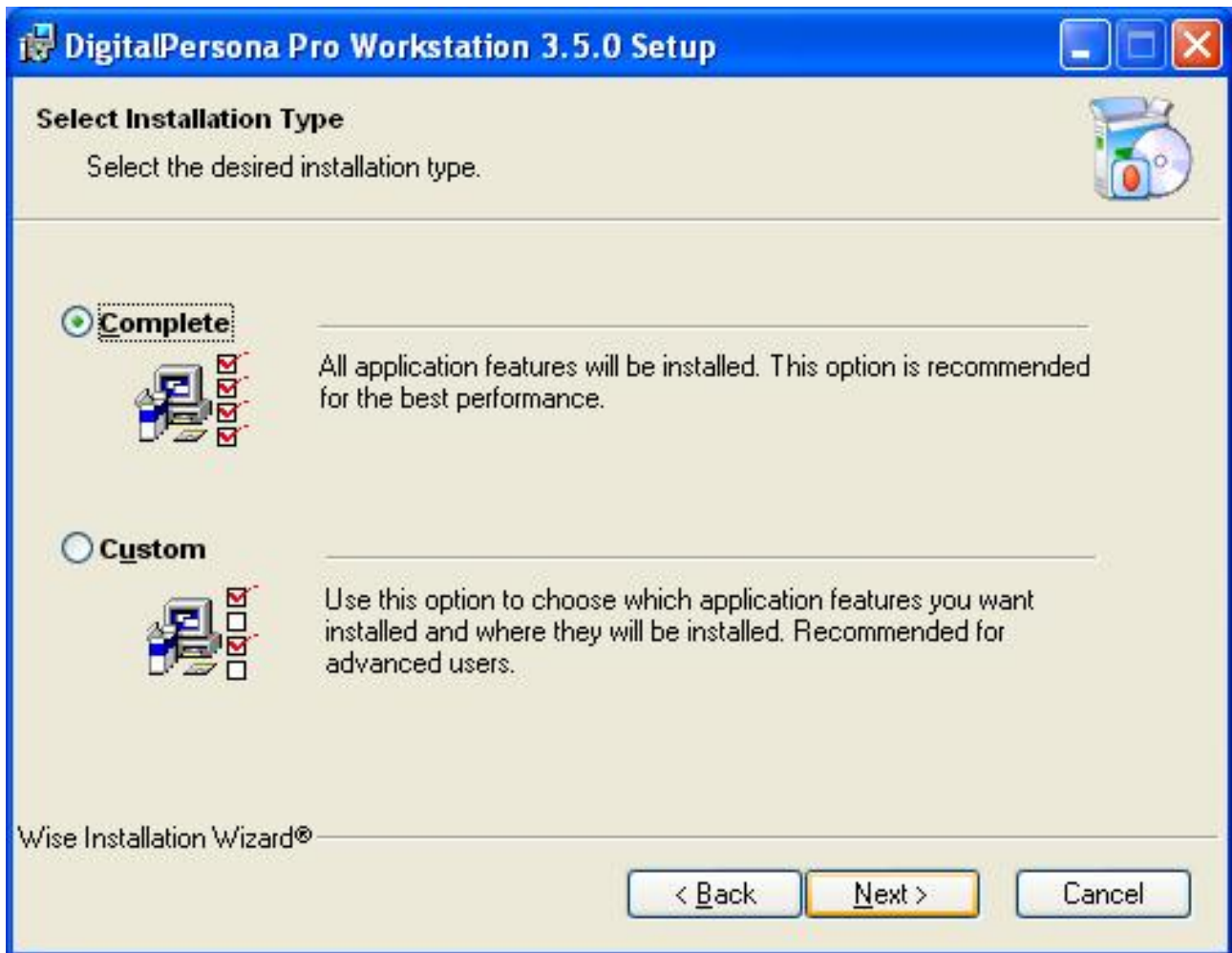

When the setup window appear then to select the "Next" step.

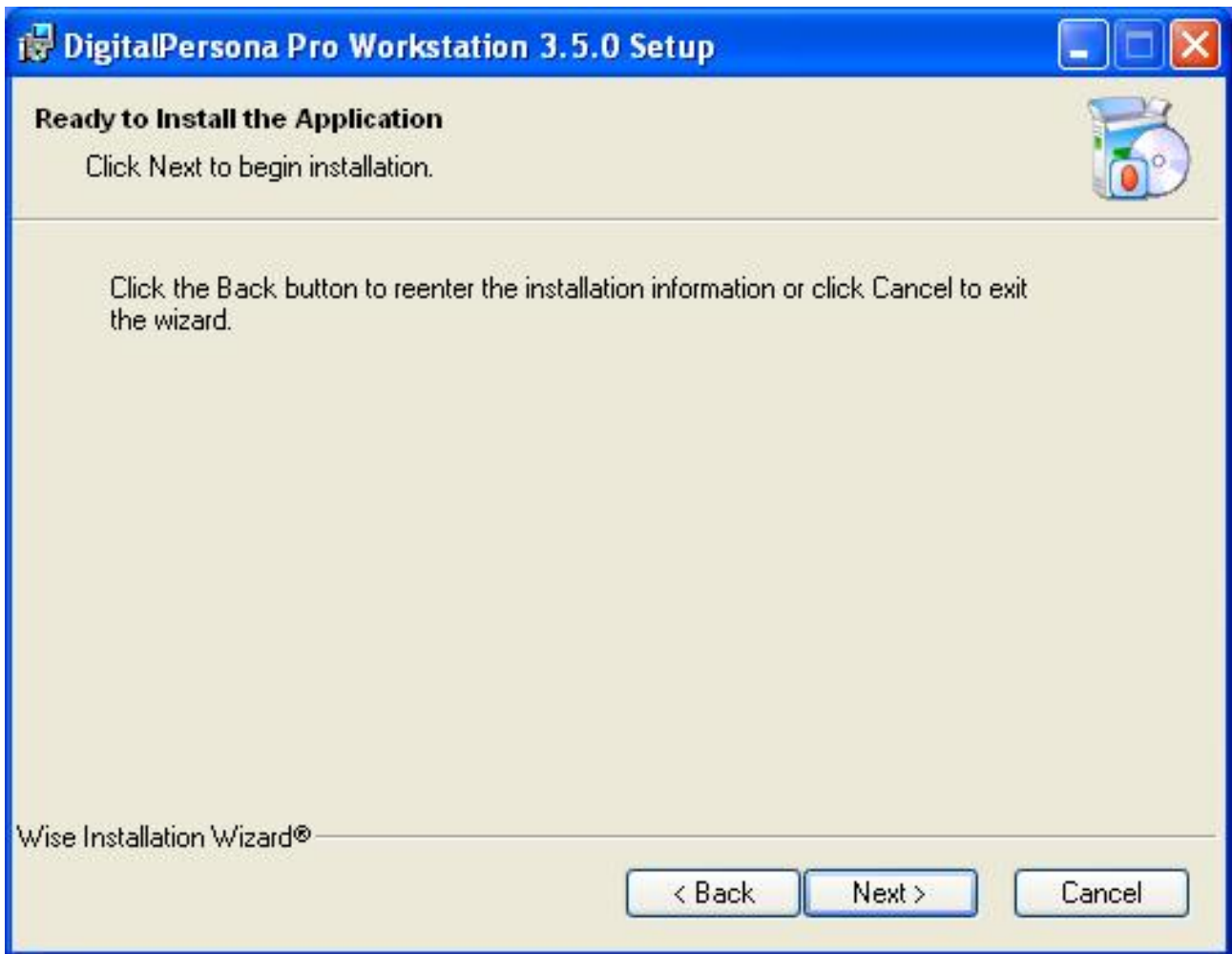

**When the setup window appear then to select the "Next" step.**

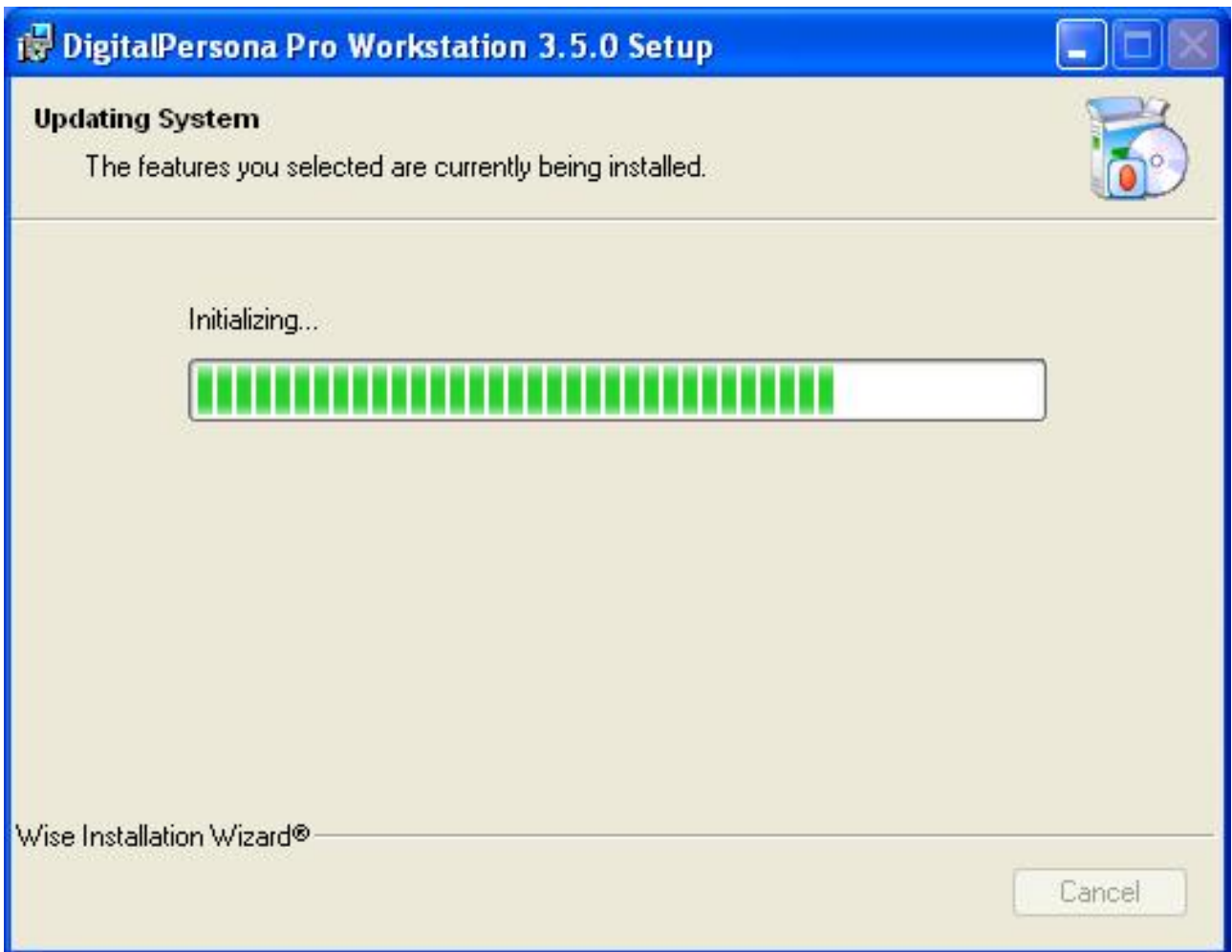

**Above screen shows the installation process window.**

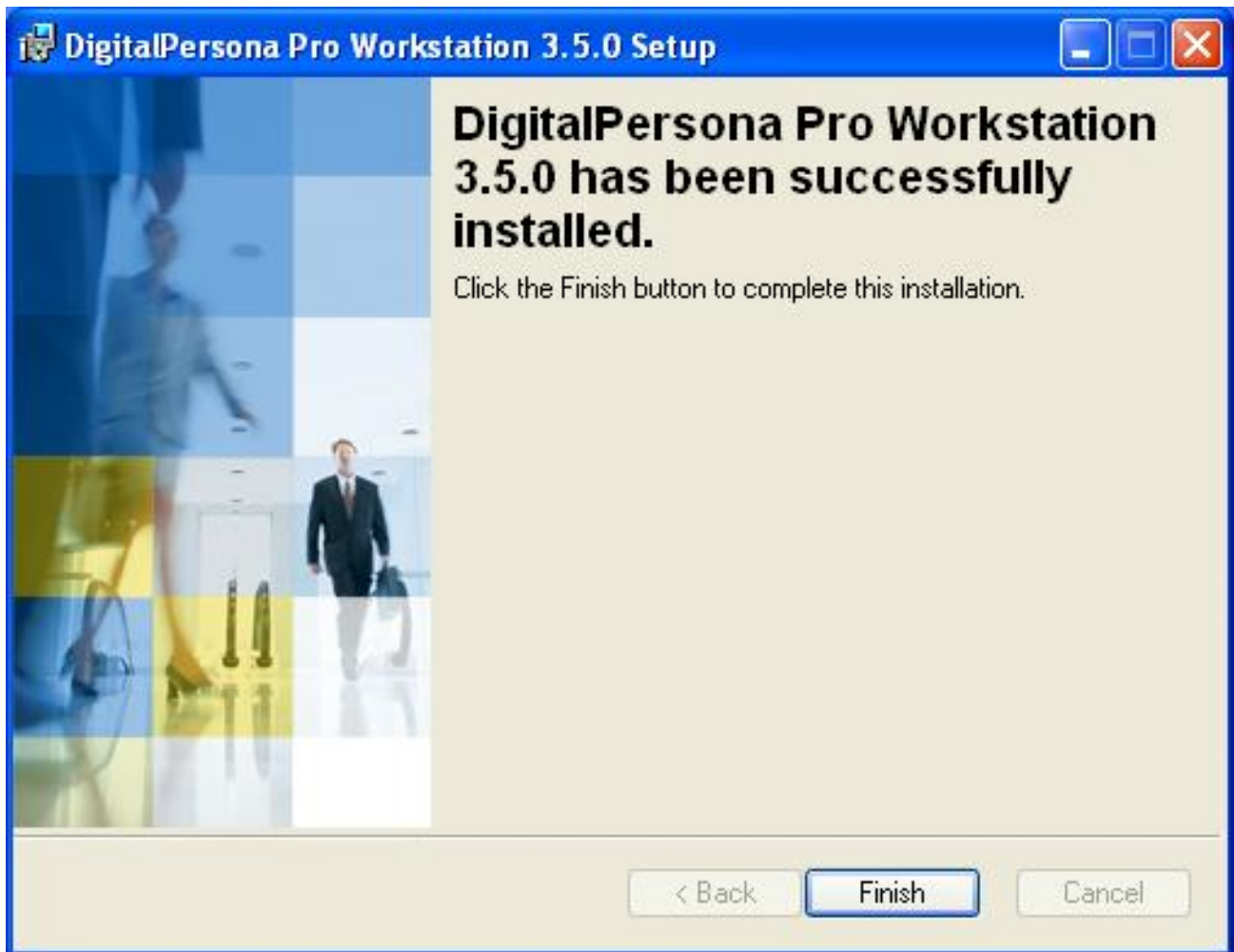

After installation complete select “Finish”.

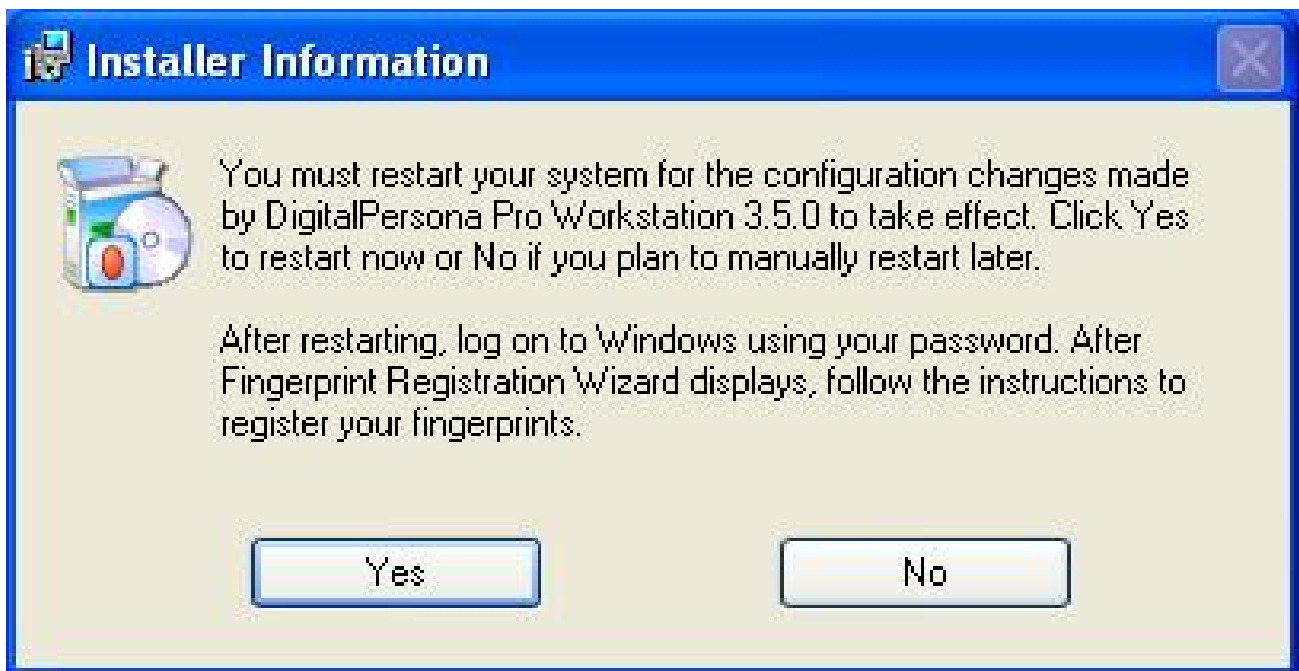

### After installation

**System will require reboot**

select **“YES”**.



**CHAPTER 4****Commands for Peripheral Controlling****RS232 Protocol: 9600bps-N-8-1****Notice: Peripheral Control must be set up "COM3"****Follow the Jarltech standard command:****Send :** <ESC> <Command code> <Length> <Data>**Response:** <ESC> <Status code><length><data>

Note: 8805 controller return a beep after power on, delay about 3 sec then turn on the Main TFT Backlight, return another beep and then start to receive the RS232 commands.

**Read products Model Name****Command :** <ESC><00h> Length & Data don't need.**Response :** <ESC><00h><07h><JP-8805>**Read Products Version info****Command :** <ESC><01h> Length & Data don't need.**Response:** <ESC><01h> <Length depends on data ><8805 POS ..... V1.0 ....>**Beeps command:****Command :** <ESC><22h> <01h><data>**<Data> = 00h ~ FFh , means how many beeps.****Response:** <ESC><22h><01h><data>**Sound command:****Command :** <ESC><24h> <02h><m><n>**m: tempo (ASCII DEC 1~255)****n: Frequency (ASCII DEC 1~255)****Response:** <ESC><24h><02h><m><n>

Example:

&lt;ESC&gt;&lt;24h&gt;&lt;02h&gt;&lt;dec 2&gt;&lt;dec 191&gt; for play sound "Do"

Example Sound frequency Table:

Do	Re	Mi	Fa	So	La	Si
				G- : 255	A- : 227	B- : 202
C : 191	D : 170	E : 151	F : 143	G : 127	A : 113	B : 101
C+ : 95	D+ : 85	E+ : 75	F+ : 71	G+ : 63	A+ : 57	B+ : 50

#### Open Cash Drawer Command :

Before send command, please confirm the S/W1 for provides voltage:

S/W1=OFF: 24V (default) S/W1=ON: 12V

The S/W2 is for setting auto response cash drawer sensor status after trigger cash drawer, or if someone manually to open the cash drawer or close the cash drawer

Then controller will auto response status to software application.

S/W2=OFF: disable (default) S/W2=ON: Enable

#### Open Cash Drawer 1

Command : <ESC> + 34h (dec 52)

When S/W2=ON response: <ESC> + 34h (dec 52) + N

N = "A" (41h, dec 65) , means Cash Drawer 1 is close.

N = "B" (42h, dec 66) , means Cash Drawer 1 is open.

#### Open Cash Drawer 2

Command : <ESC> + 35h (dec 53)

When S/W2=ON response: <ESC> + 35h (dec 53) + N

N = "A" (41h, dec 65), means Cash Drawer 2 is close.

N = "B" (42h, dec 66), means Cash Drawer 2 is open.

#### Detect Cash Drawer 1 Sensor

Command : <ESC> + 3Ah (dec 58)

Response: <ESC> + 34h (dec 52) + N

N = "A" (41h, dec 65) , means Cash Drawer 1 is close.

N = "B" (42h, dec 66) , means Cash Drawer 1 is open.

**Detect Cash Drawer 2 Sensor**

**Command : <ESC> + 3Bh (dec 59)**

Response: <ESC> + 35h (dec 53) + N

N = "A" (41h, dec 65), means Cash Drawer 2 is close.

N = "B" (42h, dec 66), means Cash Drawer 2 is open.

**Turn on the main TFT LCD backlight**

**Command : <ESC> + 38h (dec 56)**

**Turn off the main TFT LCD backlight**

**Command : <ESC> + 39h (dec 57)**

**Support Epson command to open the cash drawer:**

1. [ESC] p m t1 t2
2. DLE DC4 n m t

**CHAPTER 5**

**Hardware Configuration**

5-1. COMPONENT LOCATIONS

Placement Top View

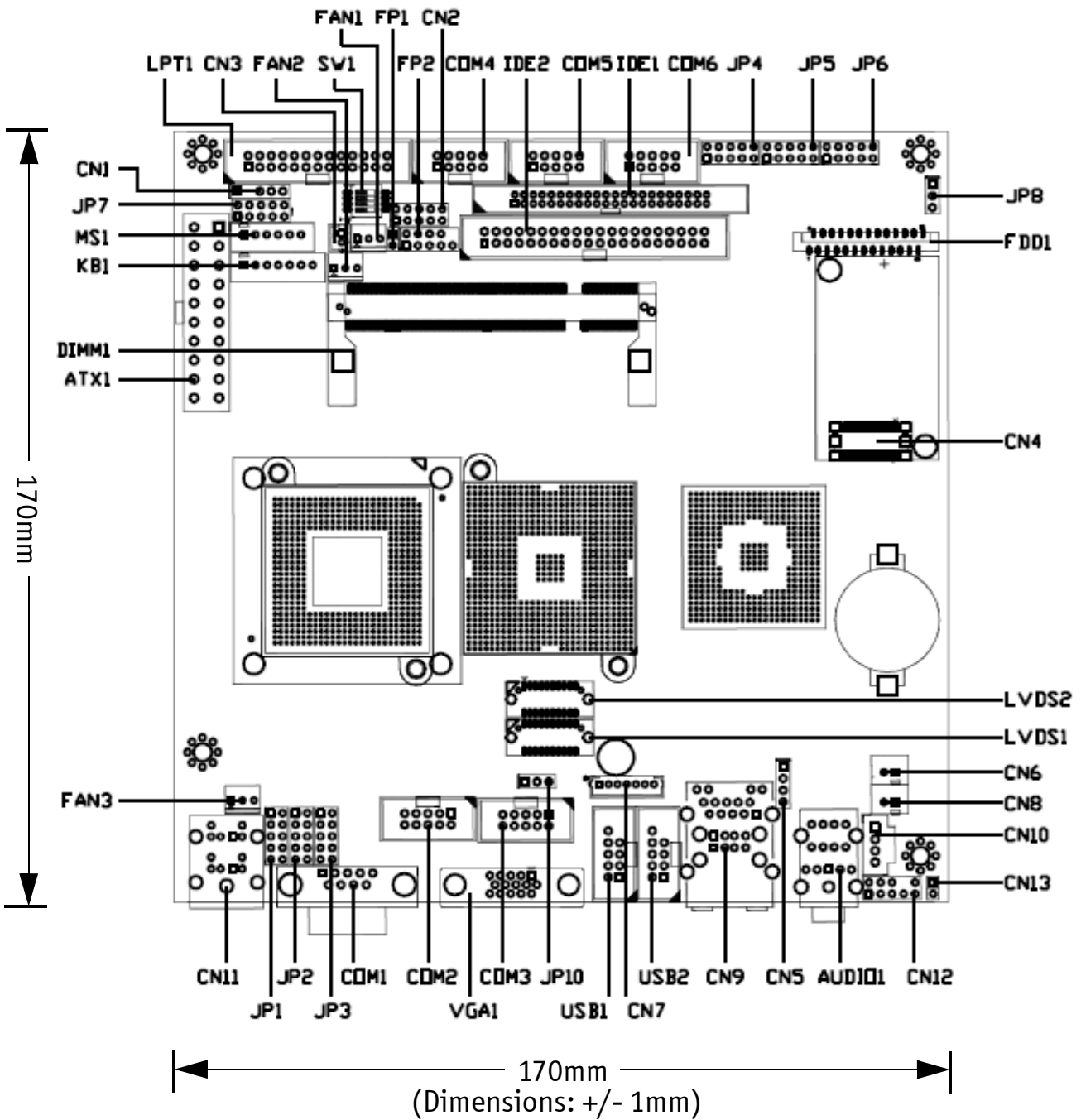

# Bottom View

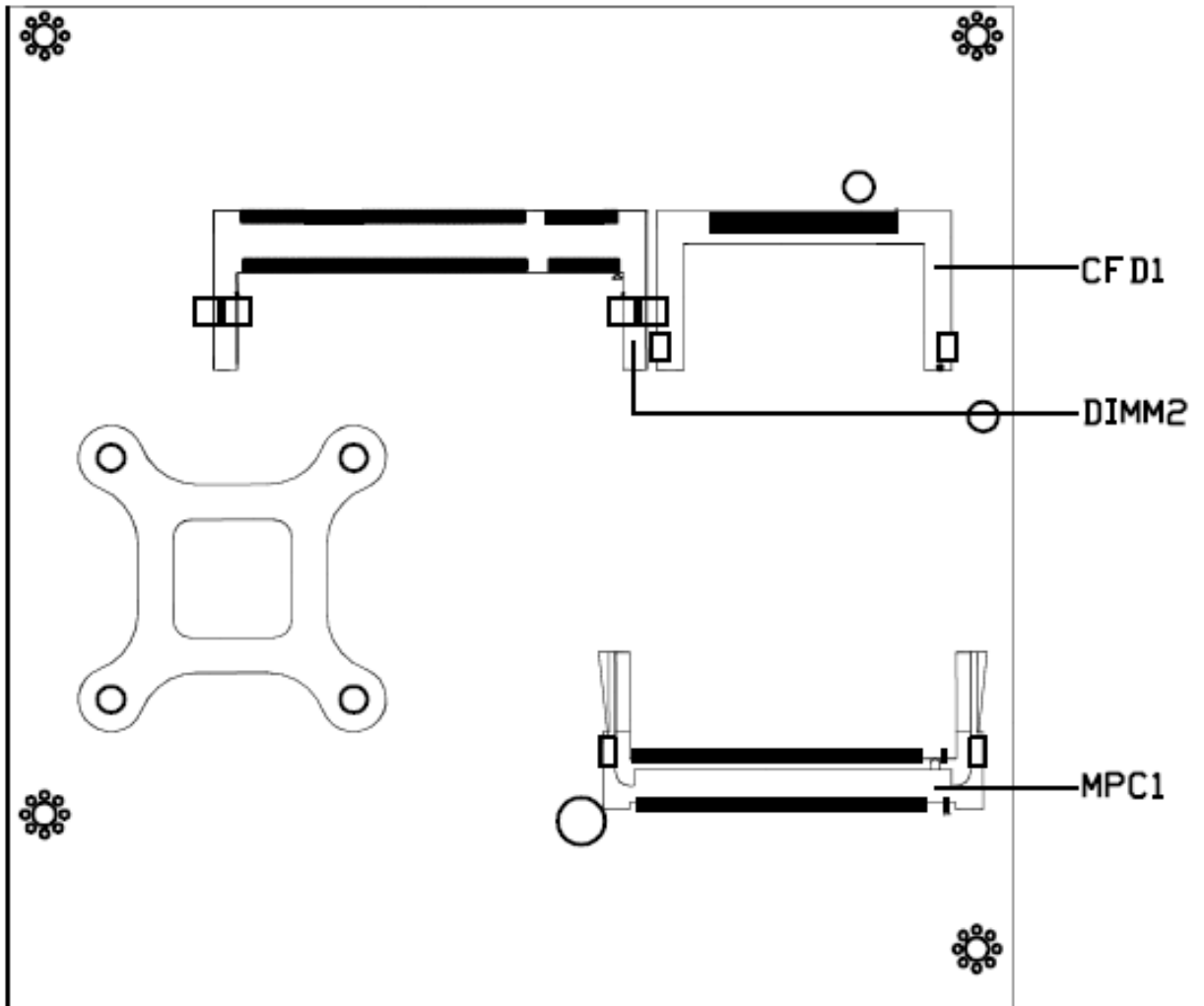

## Jumper Settings

To ensure correct system configuration, the following section describes how to set the jumpers to enable/disable or change functions. For jumper descriptions, please refer to the table below.

Location	Function
JP1	COM1 Signal / Power Selection
JP2	COM2 Signal / Power Selection
JP3	COM3 Signal / Power Selection
JP4	COM4 Signal / Power Selection
JP5	COM5 Signal / Power Selection
JP6	COM6 Signal / Power Selection
JP7	LPT1 Signal / Power Selection
JP8	CFD1 Master / Slave Selection
JP9	Clear CMOS Selection
JP10	LVDS Panel Power Selection

Table 2-1. Jumper Descriptions

### JP1 - COM1 Signal/Power Selection (Pitch: 2.54mm):

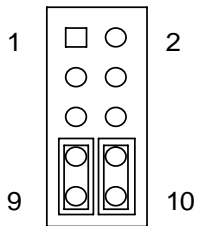

Jumper	Setting	Function
1	1-3 Short	Pin 1 of COM1 = +12V
	3-5 Short	Pin 1 of COM1 = +5V
	5-7 Short	Pin 1 of COM1 = +5V
	7-9 Short	Pin 1 of COM1 = DCD
2	2-4 Short	Pin 9 of COM1 = +12V
	4-6 Short	Pin 9 of COM1 = +5V
	6-8 Short	Pin 9 of COM1 = +5V
	8-10 Short	Pin 9 of COM1 = RI

Table 2-2. JP1 - COM1 Signal/Power Selection Settings

### JP2 - COM2 Signal/Power Selection (Pitch: 2.54mm):

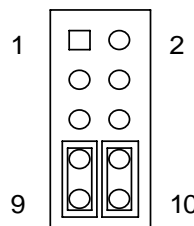

Jumper	Setting	Function
1	1-3 Short	Pin 1 of COM2 = +12V
	3-5 Short	Pin 1 of COM2 = +5V
	5-7 Short	Pin 1 of COM2 = +5V
	7-9 Short	Pin 1 of COM2 = DCD@RS232, TX+@RS422, RTX+@RS485
2	2-4 Short	Pin 8 of COM1 = +12V
	4-6 Short	Pin 8 of COM1 = +5V
	6-8 Short	Pin 8 of COM1 = +5V
	8-10 Short	Pin 8 of COM1 = RI

Table 2-3. JP1 - COM2 Signal/Power Selection Settings

*JPx - COMx Signal/Power Selection (x = 3, 4, 5, 6 - Pitch: 2.54mm):*

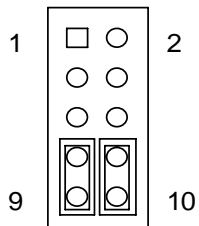

Jumper	Setting	Function
1	1-3 Short	Pin 1 of COMx = +12V
	3-5 Short	Pin 1 of COMx = +5V
	5-7 Short	Pin 1 of COMx = +5V
	7-9 Short	Pin 1 of COMx = DCD
2	2-4 Short	Pin 8 of COMx = +12V
	4-6 Short	Pin 8 of COMx = +5V
	6-8 Short	Pin 8 of COMx = +5V
	8-10 Short	Pin 8 of COMx = RI

Table 2-4. JP1 - COM3-6 Signal/Power Selection Settings

*JP7 - LPT1 Signal/Power Selection (Pitch: 2.54mm):*

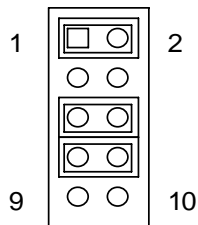

Jumper	Setting	Function
1	1-2 Short	Pin 4 of LPT1 = ERR#
	1-3 Short	Pin 4 of LPT1 = +5V
2	4-6 Short	Pin 6 of LPT1 = +5V
	5-6 Short	Pin 6 of LPT1 = INIT#
3	7-8 Short	Pin 8 of LPT1 = SLIN#
	7-9 Short	Pin 8 of LPT1 = +5V

Table 2-5. JP1 - LPT1 Signal/Power Selection

*CF Master/Slave Selector (JP8: 3-pin 2.54mm pitch header):*

Function	JP1
Master	1-2 Short
Slave (Default)	2-3 Short



Table 2-6. CF Master/Slave Setting

*Clear CMOS setting (JP9: 2-pin 2.54mm pitch header):*

Function	JP2
Normal (Default)	Open
Clear CMOS	Short

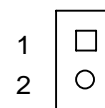

Table 2-7. Clear CMOS Setting

Panel Power Selector (JP10: 3-pin 2.54mm pitch header):

Function	JP3
+ 3.3 V (Default)	1-2 Short
+ 5 V	2-3 Short

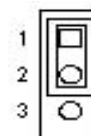

Table 2-8. Panel Power Setting

## Connector Pin Definitions

For Main Board connector and header descriptions, please refer to the table below.

Connector	Function
ATX1	ATX Power Connector
CFD1	Compact Flash type I/II Connector
CN1	IrDA Pin Header
CN2	Digital Input / Digital Output Pin Header
CN3	SM Bus Wafer
CN6	Left Audio AMP Output Wafer
CN7	LVDS Backlight Inverter Wafer
CN8	Right Audio AMP Output Wafer
COM2	RS-232 / 422 / 485 Port-2 Box Header
COM3	RS-232 Port-3 Box Header
COM4	RS-232 Port-4 Box Header
COM5	RS-232 Port-5 Box Header
COM6	RS-232 Port-6 Box Header
DIMM1	Primary DDR SO-DIMM Socket
DIMM2	Secondary DDR SO-DIMM Socket
FAN1	FAN 1 Connector
FAN2	FAN 2 Connector
FAN3	FAN 3 Connector
FDD1	Slim Type Floppy Connector
FP1	Power LED Pin Header
FP2	Front Panel Pin Header
IDE1	Primary 44-pin IDE Box Header
IDE2	Secondary 40-pin IDE Box Header
KB1	Internal PS/2 Keyboard Wafer
LVDS1	Channel 1 LVDS Connector
LVDS2	Channel 2 LVDS Connector
MPCI1	Mini-PCI Socket
MS1	Internal PS/2 Mouse Wafer
SW1	External PS/2 KB/MS Switch
USB1	USB Port-2&3 Box Header
USB2	USB Port-4&5 Box Header

Table 2-9. Main Board Connector and Header Descriptions



*ATX Power Connector (ATX1: 10x2 pin female):*

PIN	SIGNAL	PIN	SIGNAL
1	+3.3V	11	+3.3V
2	+3.3V	12	-12V
3	Ground	13	Ground
4	+5V	14	PS-ON
5	Ground	15	Ground
6	+5V	16	Ground
7	Ground	17	Ground
8	PW-OK	18	-5V
9	5VSB	19	+5V
10	+12V	20	+5V

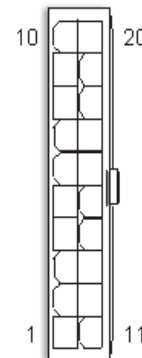

Table 2-10. ATX Power Connector pin definition

*CompactFlash slot (CFD1):*

PIN	SIGNAL	PIN	SIGNAL
1	GND	2	D3
3	D4	4	D5
5	D6	6	D7
7	CS0#	8	A10
9	ATASEL#	10	A9
11	A8	12	A7
13	VCC	14	A6
15	A5	16	A4
17	A3	18	A2
19	A1	20	A0
21	D0	22	D1
23	D2	24	IOCS16#
25	CD2	26	CD1
27	D11	28	D12
29	D13	30	D14
31	D15	32	CS1#
33	VS1	34	IORD#
35	IOWR#	36	WE#
37	INTRQ	38	VCC
39	CSEL#	40	VS2#
41	RESSET#	42	IORDY
43	INPACK#	44	REG#
45	DASP#	46	PDIAG#
47	D8	48	D9
49	D10	50	GND

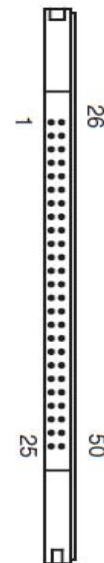
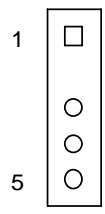

Table 2-11. CompactFlash Slot pin definition

*IrDA Pin Header (CN1: 5x2-pin header 2.54mm pitch):*



Pin	Signal Name
1	+5V
2	NC
3	IRRX
4	GND
5	IRTX

Table 2-12. Digital I/O Pin Header pin definition

*Digital I/O Pin Header (CN2: 5x2-pin header 2.54mm pitch):*

PIN	SIGNAL	PIN	SIGNAL
1	D00	2	DIO
3	D01	4	DI1
5	D02	6	DI2
7	D03	8	DI3
9	+5V	10	GND

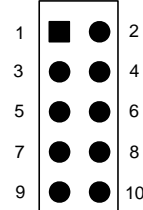
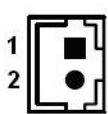

Table 2-13. Digital I/O Pin Header pin definition

*SMBus Wafer (CN3: 2x1-pin Wafer 2.0mm pitch):*



Pin	Status
1	SMDAT
2	SMCLK

Table 2-14. SMBus Header pin definition

*Left Audio AMP Output Wafer (CN6: 2x1-pin Wafer 2.5mm pitch):*



Pin	Signal Name
1	Speaker+
2	Speaker-

Table 2-15. Left Audio AMP Output Header pin definition

*LVDS Backlight Inverter (CN7: 7x1-pin Wafer 2.0mm pitch):*



Pin	Signal Name
1	+12V
2	+12V
3	+5V
4	GND
5	GND
6	Black Light Enable
7	Back Light Control

Table 2-16. LVDS Backlight Inverter Header pin definition

Right Audio AMP Output Wafer (CN8: 2x1-pin Wafer 2.5mm pitch):

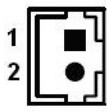

Pin	Signal Name
1	Speaker+
2	Speaker-

Table 2-17. Right Audio AMP Output Header pin definition

RS232/422/485 Serial Port Header (COM2: 5x2 box header 2.54mm pitch):

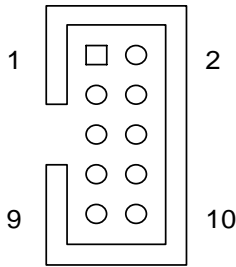

Pin	Signal
1	+5V / +12V / RS-232 : DCD, Data carrier detect RS-422 : TX+ RS-485 : RTX+ <b>Note : Selected by JP2</b>
2	DSR, Data set ready
3	RS-232 : RXD, Receive data RS-422 : RX+ RS-485 : N/A
4	RTS, Request to send
5	RS-232 : TXD, Transmit data RS-422 : TX- RS-485 : RTX-
6	CTS, Clear to send
7	RS-232 : DTR, Data terminal ready RS-422 : RX- RS-485 : N/A
8	+5V / +12V / RI, Ring indicator <b>Note : Selected by JP2</b>
9	GND, ground
10	NC

Table 2-18. COM2 RS232/422/485 Serial Port Header pin definition

RS232 Serial Port Header (COM3-6: 5x2 box header 2.54mm pitch):

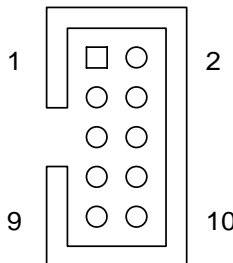

Pin	Signal
1	+5V / +12V / DCD, Data carrier detect Note : Selected by JPx
2	DSR, Data set ready
3	RXD, Receive data
4	RTS, Request to send
5	TXD, Transmit data
6	CTS, Clear to send
7	DTR, Data terminal ready
8	+5V / +12V / RI, Ring indicator <b>Note : Selected by JPx</b>
9	GND, ground
10	NC

(x = 3, 4, 5, 6)

Table 2-19. COM3-6 RS232 Serial Port Header pin definition

Fan Connectors (Fan1-3: Wafer 2.54mm pitch):

PIN	SIGNAL
1	RPM
2	+12V
3	GDN

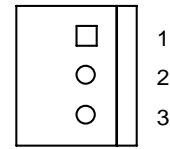

Table 2-20. Fan Connectors pin definition

Power LED Pin Header 1 (FP1: 2x1-pin 2.54mm pitch):

Pin	Status
1	Power LED +
2	Power LED -

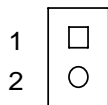

Table 2-21. Power LED Pin Header 1 pin definition

Front Panel Pin Header 2 (FP2: 5x2-pin 2.54mm pitch):

PIN	SIGNAL	PIN	SIGNAL
1	HDD LED +	2	Power LED +
3	HDD LED -	4	Power LED -
5	Reset Swatch -	6	Power Switch +
7	Reset Swatch +	8	Power Switch -
9	NC	10	Key

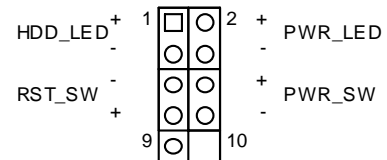

Table 2-22. Front Panel Pin Header 2 pin definition

IDE1 Connector (IDE1: 22x2 box header 2.0mm pitch):

PIN	SIGNAL	PIN	SIGNAL
1	Reset IDE	2	GND
3	IDE Data 7	4	IDE Data 8
5	IDE Data 6	6	IDE Data 9
7	IDE Data 5	8	IDE Data 10
9	IDE Data 4	10	IDE Data 11
11	IDE Data 3	12	IDE Data 12
13	IDE Data 2	14	IDE Data 13
15	IDE Data 1	16	IDE Data 14
17	IDE Data 0	18	IDE Data 15
19	Ground	20	NC
21	DREQO	22	GND
23	IDEIOW#	24	GND
25	IDEIOR#	26	GND
27	IDEIORDY	28	CBSSEL
29	DACKO#	30	GND
31	IDEIRQ14	32	NC
33	IDE Address 1	34	PDIAG#
35	IDE Address 0	36	IDE Address 2
37	IDE Chip select 1#	38	IDE Chip select 3#
39	IDE activity	40	GND
41	+5V	42	+5V
43	GND	44	NC

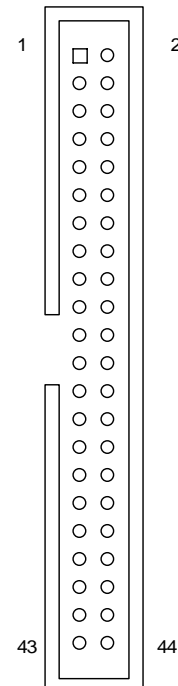

Table 2-23. IDE1 Connector pin definition

*IDE2 Connector (IDE2: 20x2 box header 2.54mm pitch):*

PIN	SIGNAL	PIN	SIGNAL
1	IDE RESET	2	GND
3	DATA7	4	DATA8
5	DATA6	6	DATA9
7	DATA5	8	DATA10
9	DATA4	10	DATA11
11	DATA3	12	DATA12
13	DATA2	14	DATA13
15	DATA1	16	DATA14
17	DATA0	18	DATA15
19	GND	20	N.C
21	REQ	22	GND
23	IO WRITE	24	GND
25	IO READ	26	GND
27	IO READY	28	GND
29	DACK	30	GND
31	IRQ14	32	N.C
33	ADDR1	34	UDMA DETECT
35	ADDR0	36	ADDR2
37	CS#1	38	CS#3
39	LED	40	GND

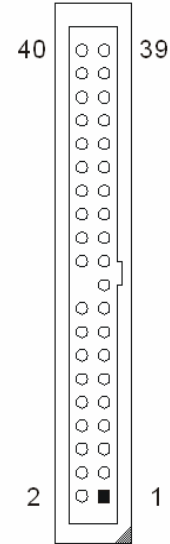
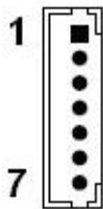

Table 2-24. IDE2 Connector pin definition

*Internal PS/2 KB (KB1: Wafer 2.5mm pitch):*



Pin	Signal Name
1	+12V
2	+5V
3	KBCLK_SIO
4	KBDAT_SIO
5	KBCLK_PS2
6	KBDAT_PS2
7	GND

Table 2-25. Internal KB Wafer pin definition

Parallel Port Box Header (LPT1: 2.54mm):

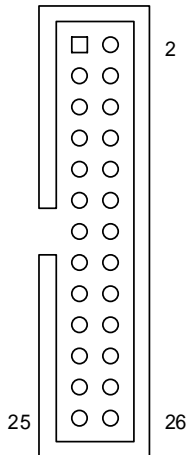

Pin	Signal	Pin	Signal
1	Strob#, Line printer strobe	2	AutoFeed
3	PD0, parallel data 0	4	Error / +5V <b>Note : Selected by JP7</b>
5	PD1, parallel data 1	6	Initialize / +5V <b>Note : Selected by JP7</b>
7	PD2, parallel data 2	8	Select In / +5V <b>Note : Selected by JP7</b>
9	PD3, parallel data 3	10	GND
11	PD4, parallel data 4	12	GND
13	PD5, parallel data 5	14	GND
15	PD6, parallel data 6	16	GND
17	PD7, parallel data 7	18	GND
19	ACK, acknowledge	20	GND
21	Busy	22	GND
23	Paper empty	24	GND
25	Select	26	NC

Table 2-26. Parallel Port pin definition

LVDS1-2 Channel 1-2 Connector (LVDS1-2: Hirose DF13 1.25mm):

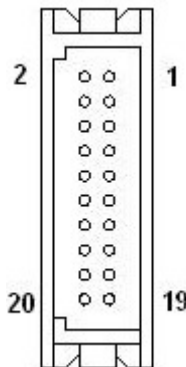

Signal Name	Pin	Pin	Signal Name
+3.3V / +5V <b>Note : Selected by JP10</b>	1	2	+3.3V / +5V <b>Note : Selected by JP10</b>
+3.3V / +5V <b>Note : Selected by JP10</b>	3	4	+3.3V / +5V <b>Note : Selected by JP10</b>
LVDS_TX0-	5	6	LVDS_TX3-
LVDS_TX0+	7	8	LVDS_TX3+
GND	9	10	GND
LVDS_TX1-	11	12	LVDS_CLK-
LVDS_TX1+	13	14	LVDS_CLK+
GND	15	16	GND
LVDS_TX2-	17	18	GND
LVDS_TX2+	19	20	GND

Table 2-27. LVDS1-2 Connector pin definition

Internal PS/2 Mouse (MS1: Wafer 2.5mm pitch):

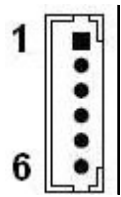

Pin	Signal Name
1	+5V
2	MSCLK_SIO
3	MSDAT_SIO
4	MSCLK_PS2
5	MSDAT_PS2
6	GND

Table 2-28. Internal Mouse Wafer pin definition

External PS/2 KB/Mouse Switch (SW1):

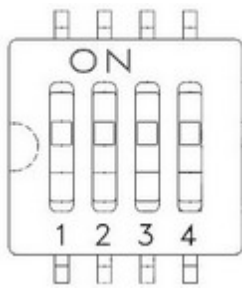

Switch	Status	Function
1	ON	KBCLK_SIO and KBCLK_PS2 are shorted.
	OFF	KBCLK_SIO and KBCLK_PS2 are open.
2	ON	KBDAT_SIO and KBDAT_PS2 are shorted.
	OFF	KBDAT_SIO and KBDAT_PS2 are open.
3	ON	MSCLK_SIO and MSCLK_PS2 are shorted.
	OFF	MSCLK_SIO and MSCLK_PS2 are open.
4	ON	MSDAT_SIO and MSDAT_PS2 are shorted.
	OFF	MSDAT_SIO and MSDAT_PS2 are open.

Table 2-29. External PS/2 KB/Mouse switch

USB2-3 Ports Header (USB1: 5x2-pin header 2.54mm pitch):

PIN	SIGNAL	PIN	SIGNAL
1	+5V	2	+5V
3	USBD2-	4	USBD3-
5	USBD2+	6	USBD3+
7	GND	8	GND
9	"key"	10	GND

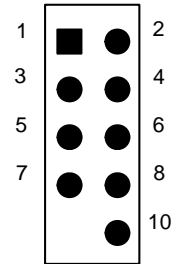

Table 2-30. USB1 Header pin definition

USB4-5 Ports Header (USB2: 5x2-pin header 2.54mm pitch):

PIN	SIGNAL	PIN	SIGNAL
1	+5V	2	+5V
3	USBD4-	4	USBD5-
5	USBD4+	6	USBD5+
7	GND	8	GND
9	"key"	10	GND

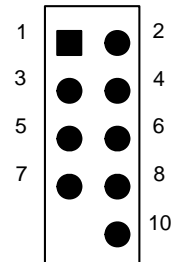

Table 2-31. USB2 Header pin definition

## Pin Definitions - Rear Panel

Location	Function
AUDIO1	Audio Phone Jack
COM1	RS-232 Port-1 DB9 Connector
CN9	RJ-45 + USB Port-0&1 Connector
CN11	Mini-DIN PS/2 KB/MS Connector
VGA1	CRT DB-15 Connector

Table 2-32. KEOD-4014 Rear Panel Connector Descriptions

Audio Jack Connector (AUDIO1: audio jack connector):

COLOR	SIGNAL
Blue	Line-in
Green	Line- out
Pink	MIC-in



Table 2-33. Audio Jack Connector pin definition

COM1 RS-232 Serial Port Connector (COM1: D-Sub 9-pin male):

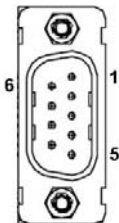

Pin	Signal
1	+5V / +12V / DCD, Data carrier detect <b>Note : Selected by JP1</b>
2	RXD, Receive data
3	TXD, Transmit data
4	DTR, Data terminal ready
5	GND, ground
6	DSR, Data set ready
7	RTS, Request to send
8	CTS, Clear to send
9	+5V / +12V / RI, Ring indicator <b>Note : Selected by JP1</b>

Table 2-34. COM1 RS-232 Serial Port Connector pin definition



*PS/2 Mouse Connector (CN11: 6-pin green Mini DIN):*

PIN	SIGNAL	PIN	SIGNAL
1	Mouse data	2	NC
3	Ground	4	+5V
5	Mouse clock	6	NC

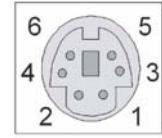

Table 2-35. PS/2 Mouse Connector pin definition

*PS/2 Keyboard Connector (CN11: 6-pin purple Mini DIN):*

PIN	SIGNAL	PIN	SIGNAL
1	Keyboard data	2	NC
3	Ground	4	+5V
5	Keyboard clock	6	NC

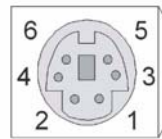

Table 2-36. PS/2 Keyboard Connector pin definition

*VGA Display Connector (VGA1: D-Sub 15-pin female):*

PIN	SIGNAL	PIN	SIGNAL
1	Red	2	Green
3	Blue	4	NC
5	Ground	6	Ground
7	Ground	8	Ground
9	VCC	10	Ground
11	NC	12	DDCData
13	HSync	14	VSync
15	DDCClk		

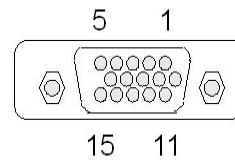

Table 2-37. VGA Display Connector pin definition

*RJ-45 + 2 USB0-1 Connector (CN9):*

PIN	SIGNAL	PIN	SIGNAL
1	Transmit output (+)	9	+5V
2	Transmit output (-)	10	USB1-
3	Receive input (+)	11	USB1+
4	NC	12	GND
5	NC	13	+5V
6	Receive input (-)	14	USB2-
7	NC	15	USB2+
8	NC	16	GND

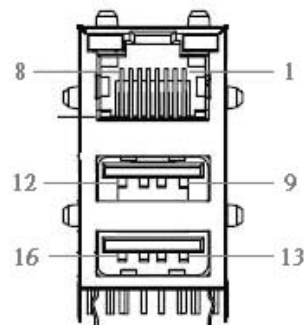
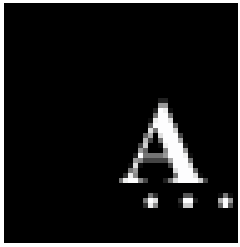

Table 2-38. RJ-45 + 2 USB 2.0 Connector pin definition

**CHAPTER 6****Hardware Specification**

<b>Motherboard</b>	
CPU	Intel® Celeron® M Processor 1.5GHz
System Memory	2 x DDR 266MHz SODIMMs, maximum 2GB
Chipset	Intel® 852GM Graphic Memory Controller Hub Intel® I/O Controller Hub 4 (ICH4)
Graphics	852GM GMCH internal ; VGA controller CRT 2048x1536x8bit@60Hz 2 channels LVDS ; Dual Display ; Shared Memory up to 64MB
Network	10/100 Base-T Ethernet RTL8100C
Audio	6-Channel AC'97 Audio CODEC ALC655 ; Stereo 2W Power Amplifier LM4838
BIOS	Award PnP 4Mb Flash with console redirection
Expansion	Mini-PCI Socket x 1
<b>Storage</b>	
HDD	Internal 1 x 3.5" HDD (20G or above) or Internal 2 x 2.5" HDD
Flash Memory	Compact Flash (Type I & II)
<b>Display</b>	
LCD	15" TFT
Max. Resolution	1024 x 768
Brightness	500~700cd/m <sup>2</sup>
Touch Screen	Resistive
<b>External I/O Ports</b>	
USB	6 x USB 2.0 ports for future expansion (2* Internal, 4*External)
Serial	2 x User available Com ports (Com 1&Com 2) .
Parallel	1 x Bi-directional Parallel Port Support ECP/EPP (IEEE 1284)
LAN	1 x RJ-45 Interface(10/100 Base-T Ethernet)
Keyboard	1 x PS/2 keyboard port
Mouse	1 x PS/2 mouse port
2nd VGA Output	1 x 10.4" TFT LCD customer display
Audio Jack	MIC-in, Line-out, Line-in
Cash Drawer	2 x RJ11Single/Dual Cashdrawer port(with 12V output.)
<b>Power</b>	
Power Supply	ATX 200W, Input 110V~240V to output 5V/12V power supply
Power Consumption	80-100W Idle(Standard system & secondary LCD panel while accessing HDD)
Power management	I/O peripheral devices support power saving management
<b>Integrated Options</b>	
CD-ROM	1 x Built-in Slim type CD-ROM
Smart Card Reader	1 x Built-In Smart Card Reader, compatible with Microsoft PC/SC (USB Interface)
Magnetic Stripe Reader	1 x Build-In Magnetic Stripe Reader (PS2/KB) : ISO Standard ( up to 3 tracks)
Customer Display	VFD Customer Display (20 x 2)
Second Display	10.4" TFT LCD (No Touch)
USB Key-Locker	1, From USB Power ON/OFF
I-Button	1 x Built-In I-Button (USB Interface)
Fingerprint	1 x Built-In Fingerprint Reader (USB Interface)( Only support WIN 98)
RFID	1 x Built-in RFID Reader( Radio Frequency Identification) (USB Interface)
Wireless LAN	Wi-Fi IEEE 802.11b/g
DM Case	1 x Acrylics Demo Case
<b>Control/ Indicator</b>	

Power Button	1		
Power Led	1		
HDD Led	1		
<b>Physical Dimensions</b>			
Dimension (W)x(L)x(H)cm	Physical:20(W) x 37(L) x 42 (H)cm		
	Pagage: 34(W) x 53(L) x 53 (H)cm		
Weight	N.W: 11.5kgs		
	G.W: 12.5Kgs		
Color	Dark Gray or White		
<b>Environment</b>			
Operating Temperature	0°C ~ 45°C (32°F ~ 113°F)	Storage Temperature	-20°C ~ 60°C (-4°F ~ 140°F)
Operating Humidity	0% ~ 80% RH non condensing	Storage Humidity	10% ~ 90% RH non condensing
<b>Certification</b>			
EMC & Safety	FCC, CE, RoHS, Class A, CCC		
<b>Operation Systems</b>			
OS support	Windows XP, XP Embedded, XP Professional for Embedded, WIN 2000 Professional Embedded, WIN NT 4.0, Redhat 7.2, WIN 98/ME, Linux		



## **Appendix : LAN Controller:**

### **REALTEK RTL8139/810x**

- Integrated Fast Ethernet MAC, Physical chip and transceiver in one chip.
- 10 Mb/s bps and 100 Mb/s operation
- PCI local bus single-chip Fast Ethernet controller
  - ✧ Compliant to PCI Revision 2.2
  - ✧ Support PCI clock 16.75MHz-40MHz
  - ✧ Provides PCI bus master data transfers and PCI memory space or I/O space mapped data transfers of RTL8100B's operational registers
  - ✧ Supports PCI VPD (Vital Product Data)
  - ✧ Supports ACPI, PCI power management
- Compliant to PC99/PC2001 standard
- Supports Wake-On-LAN function and remote wake-up
- 0.25um, 2.5/3.3V power, single chip, 100-pin PQFP.

**Jaritech Internaional Inc.**

Taipei Office: 3F, No.1, Lane 538, Chung Cheng Road, Hsin Tien City, Taipei ,Taiwan ROC.

Website: [www.jaritech.com.tw](http://www.jaritech.com.tw)

E-mail: [service@jaritech.com.tw](mailto:service@jaritech.com.tw)